

Bahnhof »Lavin«

»Lavin« Station
Gare de »Lavin«
Station »Lavin«

POLA G

Art. Nr. 330861



Sa. Nr. 330 861 1

- (D)**
- Verwenden Sie nur POLA G-Cement.
 - Machen Sie sich vor dem Zusammenbau gut mit den Einzelteilen des Bausatzes vertraut. Trennen Sie die Einzelteile erst dann ab, wenn sie gebraucht werden.
 - Verwenden Sie beim Zusammenbau wenig Klebstoff. Sie werden dann mehr Freude an einem sauberem Modell haben.
 - Sollte trotz werkseitiger sorgfältiger Prüfung ein Teil fehlen oder fehlerhaft sein, kreuzen Sie bitte das Teil in der Anleitung an und schicken Sie diese bitte an:
Gebr. FALLER GmbH, Abt. Kundendienst, kundendienst@faller.de, Kreuzstraße 9, D-78148 Gütenbach.
Sie erhalten dann umgehend Ersatz.
- (GB)**
- Use POLA G-Cement only.
 - Familiarize yourself well with the components of the kit before assembly. Do not break off the components until the moment you need them.
 - Use glue sparingly on assembly, then you will enjoy your neat model even more.
 - If a part is missing or defective despite careful checking at the factory, please mark the part concerned in your instructions and send it to:
Gebr. FALLER GmbH, Abt. Kundendienst, kundendienst@faller.de, Kreuzstraße 9, D-78148 Gütenbach, Germany.
You will receive replacement promptly.
- (F)**
- N'utilisez que la colle POLA G -Cement.
 - Avant l'assemblage, familiarisez vous avec les différentes pièces du jeu de construction. Ne séparer les pièces particulières qu'au moment de les utiliser.
 - Utiliser aussi peu de colle que possible pour l'assemblage, vous aurez d'autant plus de plaisir avec un modèle propre.
 - Si, malgré un contrôle soigneux à l'usine, une pièce devait manquer ou être défectueuse, marquer cette pièce d'une croix dans les instructions et envoyer ces dernières à:
Gebr. FALLER GmbH, Abt. Kundendienst, kundendienst@faller.de, Kreuzstraße 9, D-78148 Gütenbach (R.F.A.).
On vous la remplacera aussitôt.
- (NL)**
- Gebruik uitsluitend POLA G -cement.
 - Zorg da u vóór de montage goed weet uit welke onderdelen het bouwpakket bestaat. Maak de onderdelen pas los als u ze gaat gebruiken.
 - Gebruik bij de montage slechts weinig lijm. U zult dan meer plezier beleven aan een schoon model.
 - Mist u ondanks zorgvuldige fabrikantencontrole toch een onderdeel of is een onderdeel beschadigd, kruis dan het desbetreffende onderdeel aan in de handleiding en stuur dit s.v.p. aan:
Gebr. FALLER GmbH, Abt. Kundendienst, kundendienst@faller.de, Kreuzstraße 9, D-78148 Gütenbach, Duitsland.
Het wordt dan direct vervangen en naar u opgestuurd.



Gebr. FALLER GmbH
D - 78148 Gütenbach
Tel. +49(0)7723/6510

2

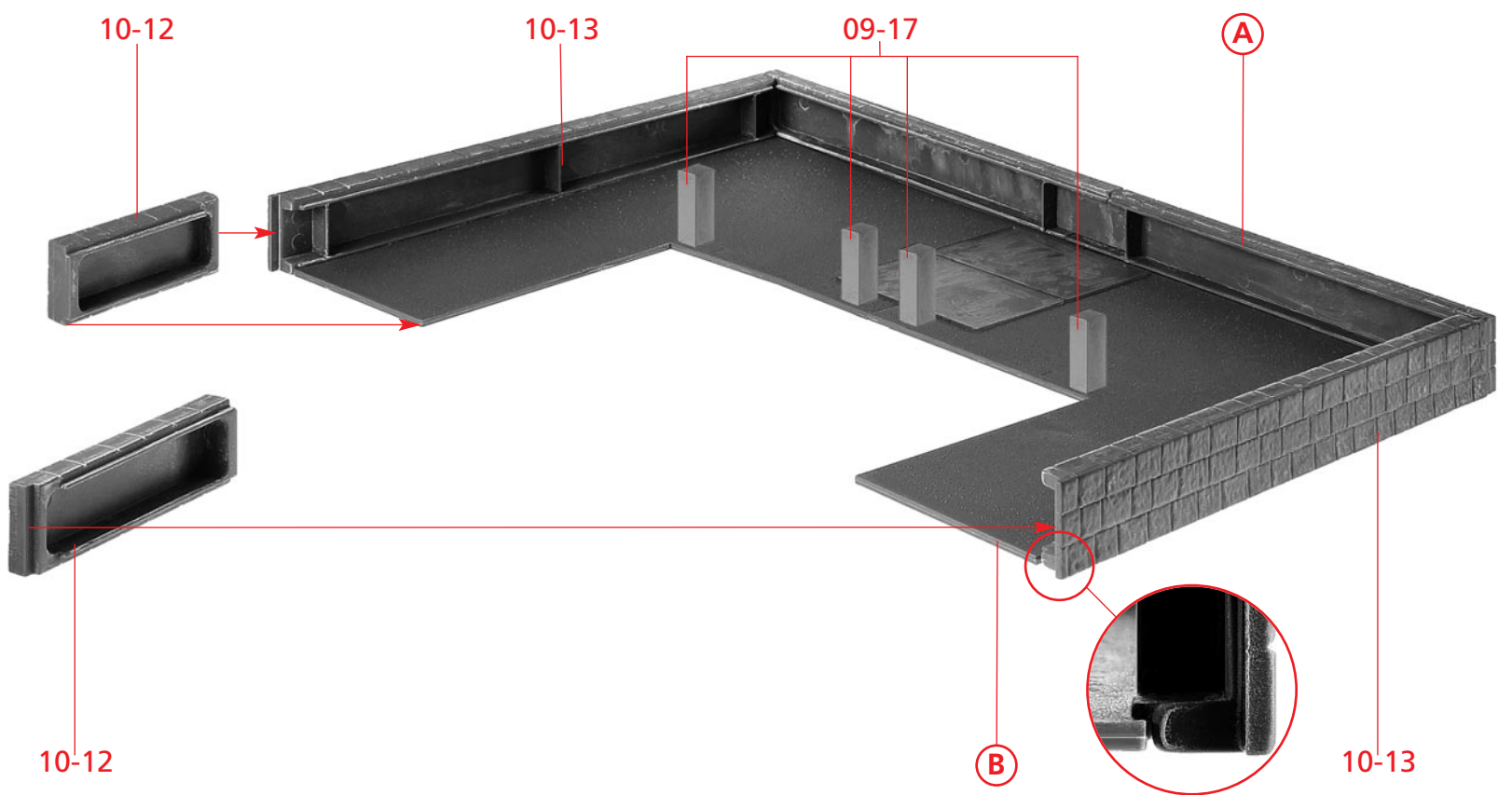
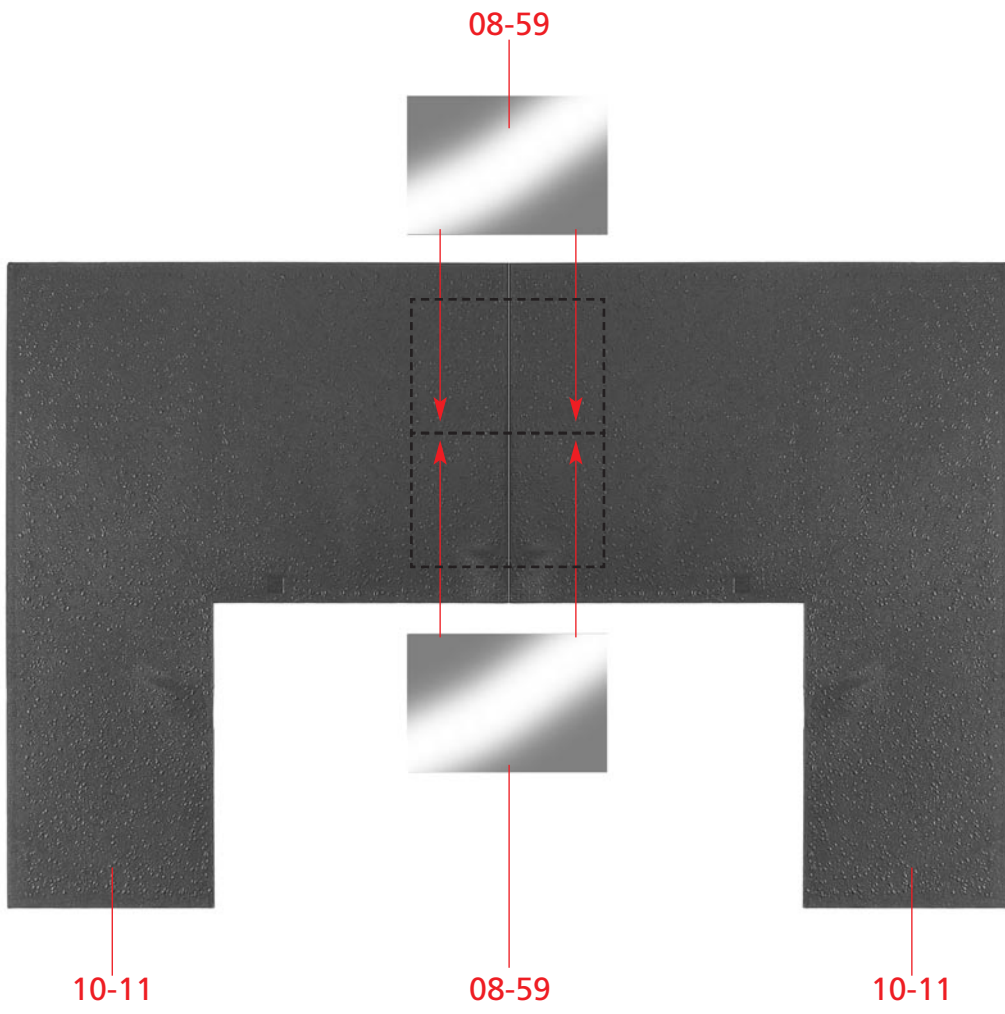
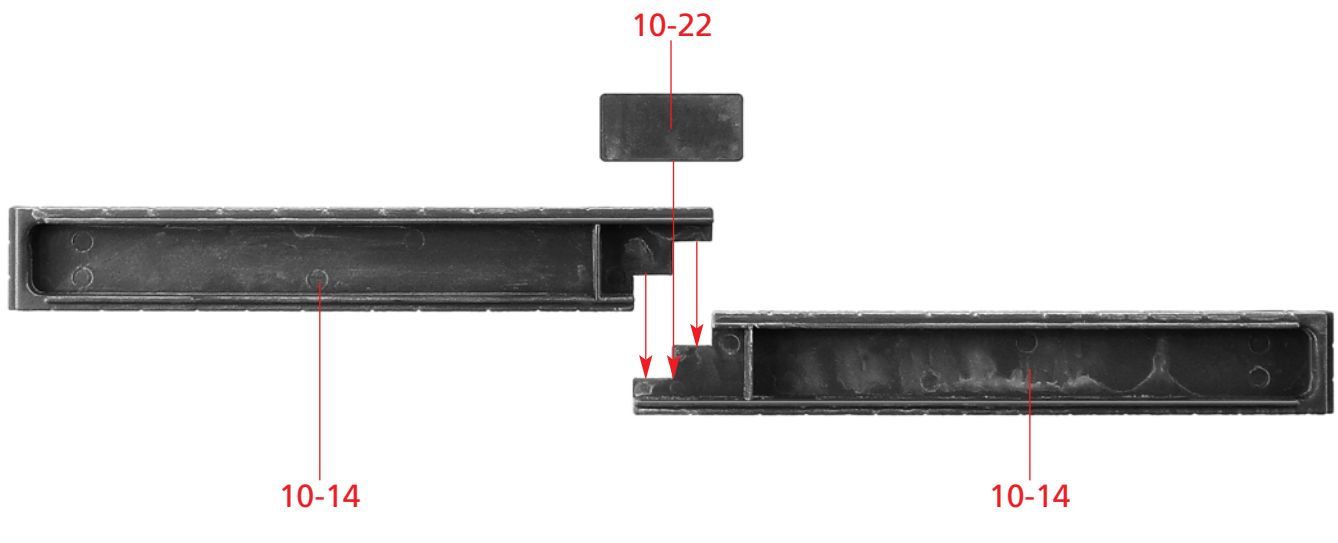

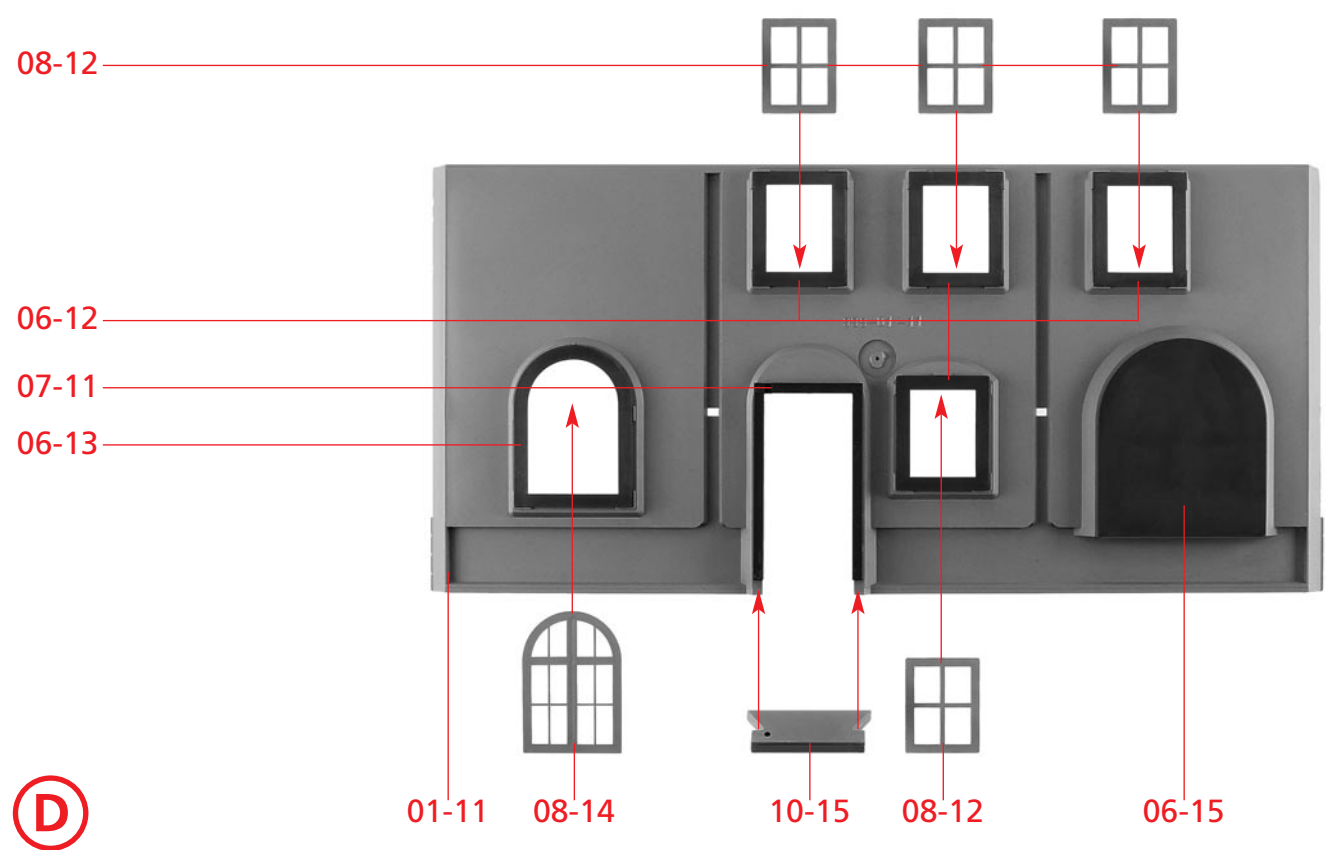

D

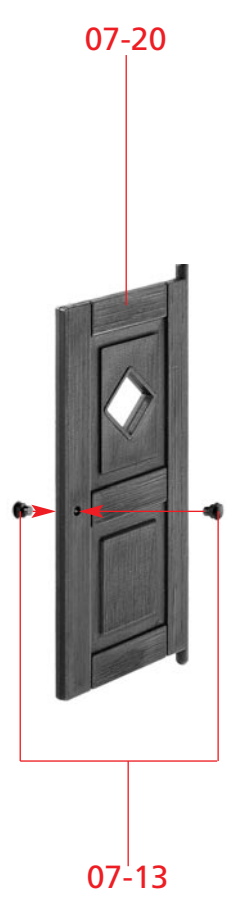

E

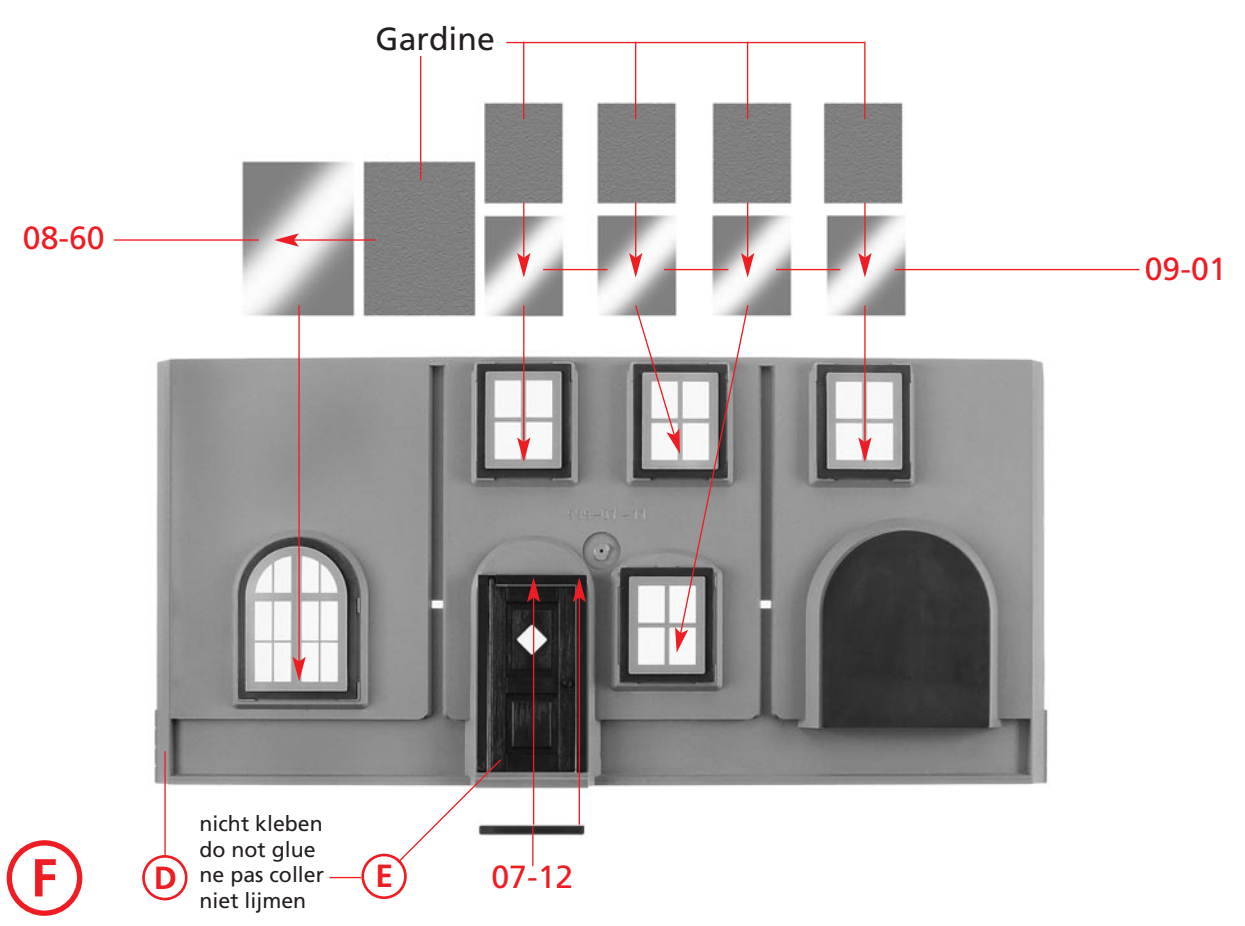

F

Deco 2

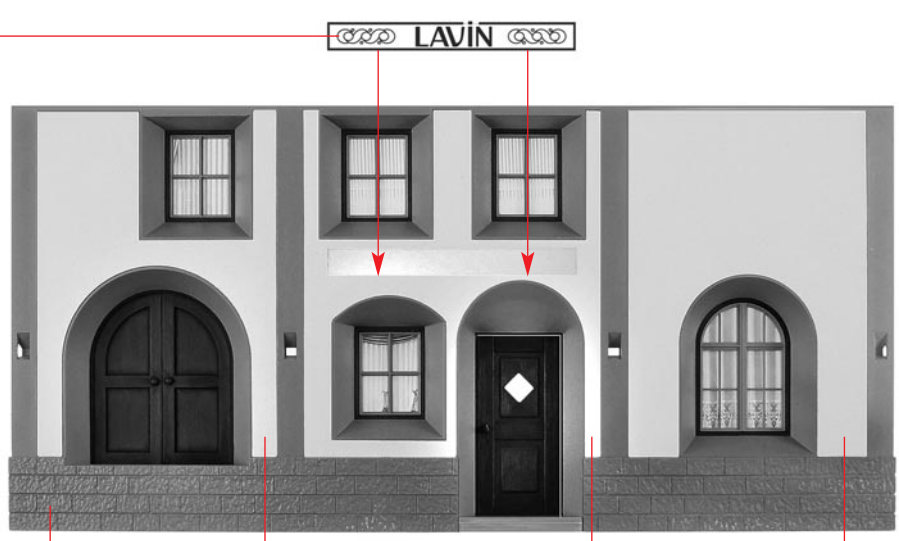

G

gelb
yellow
jaune
geel

4

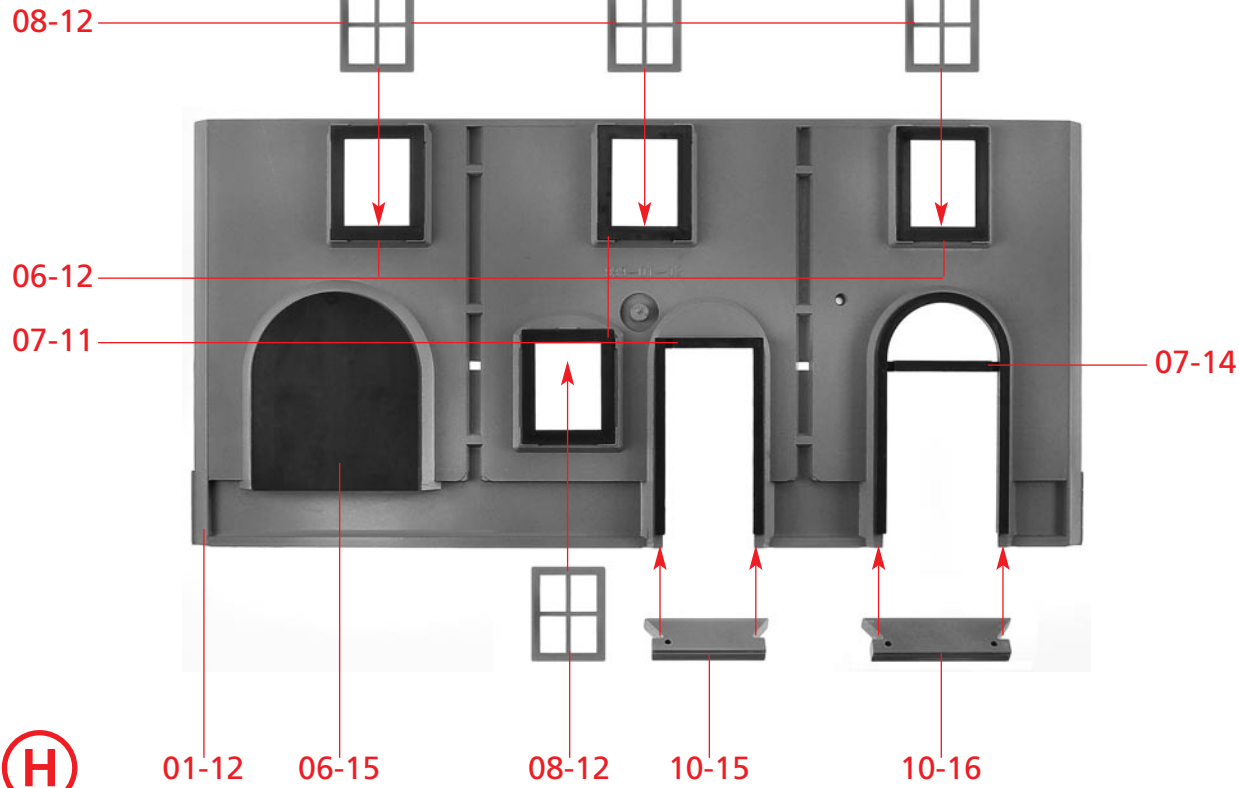

H

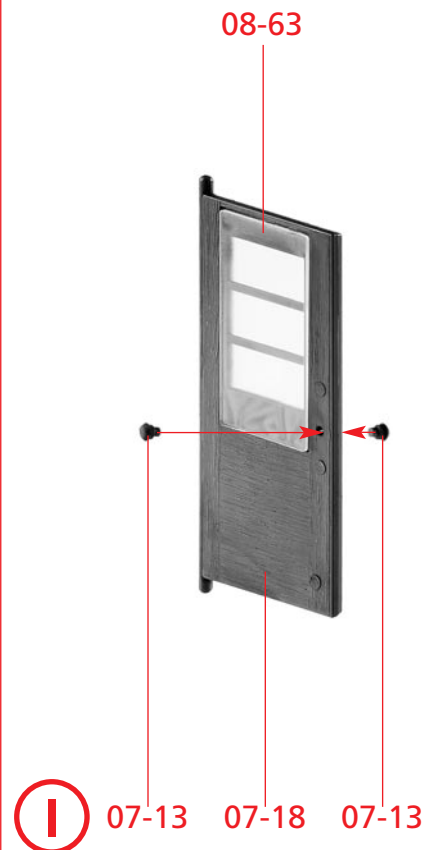

I

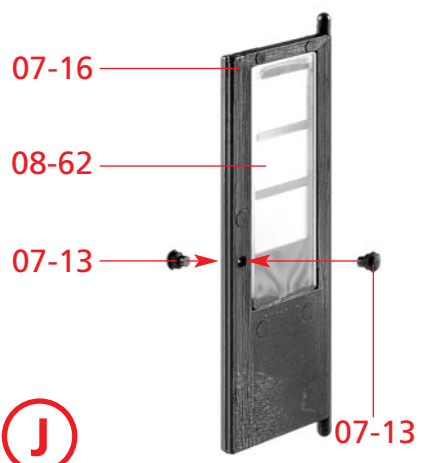

J



K

Gardine

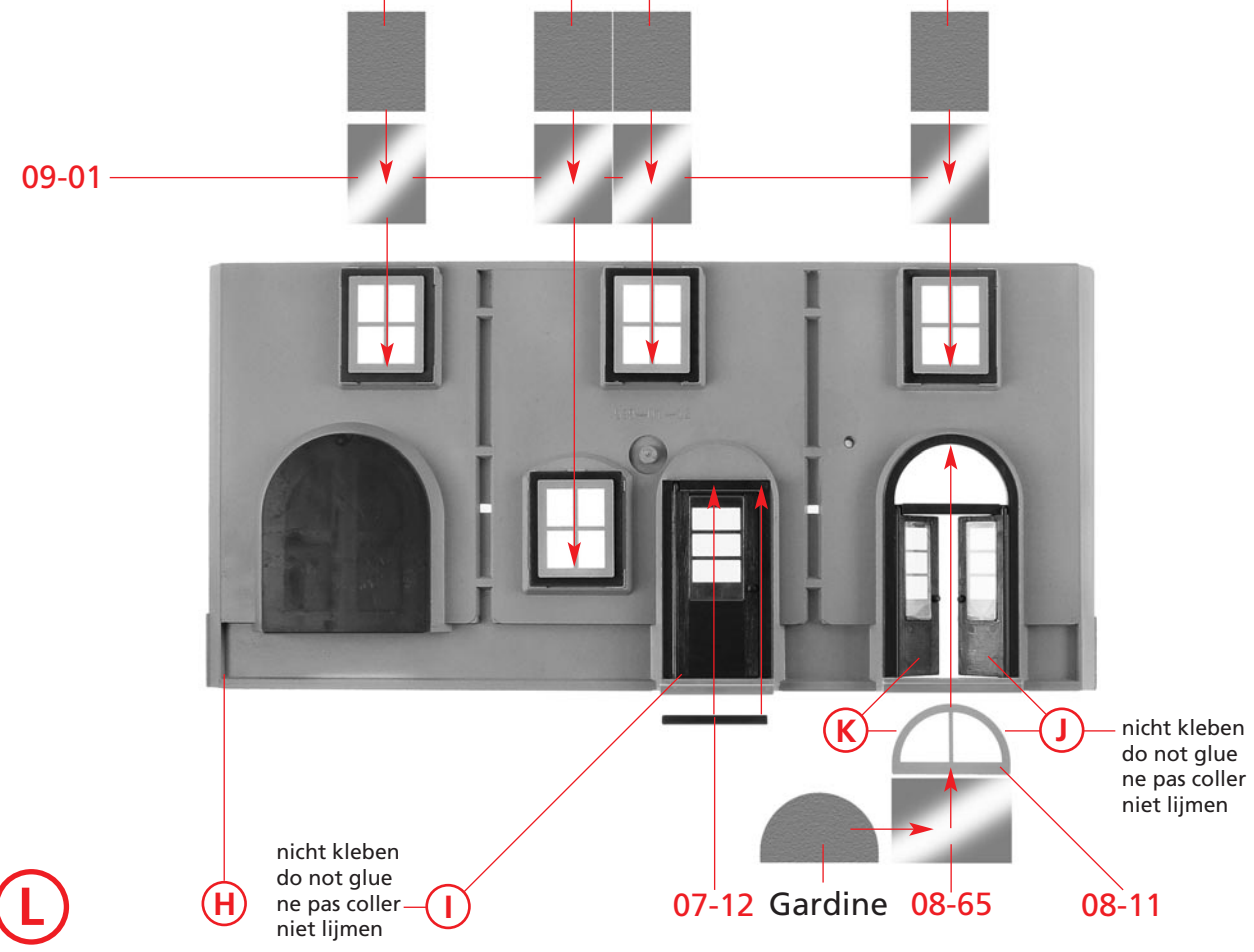

L

Deco 2



M

rosa
pink
rose
roze

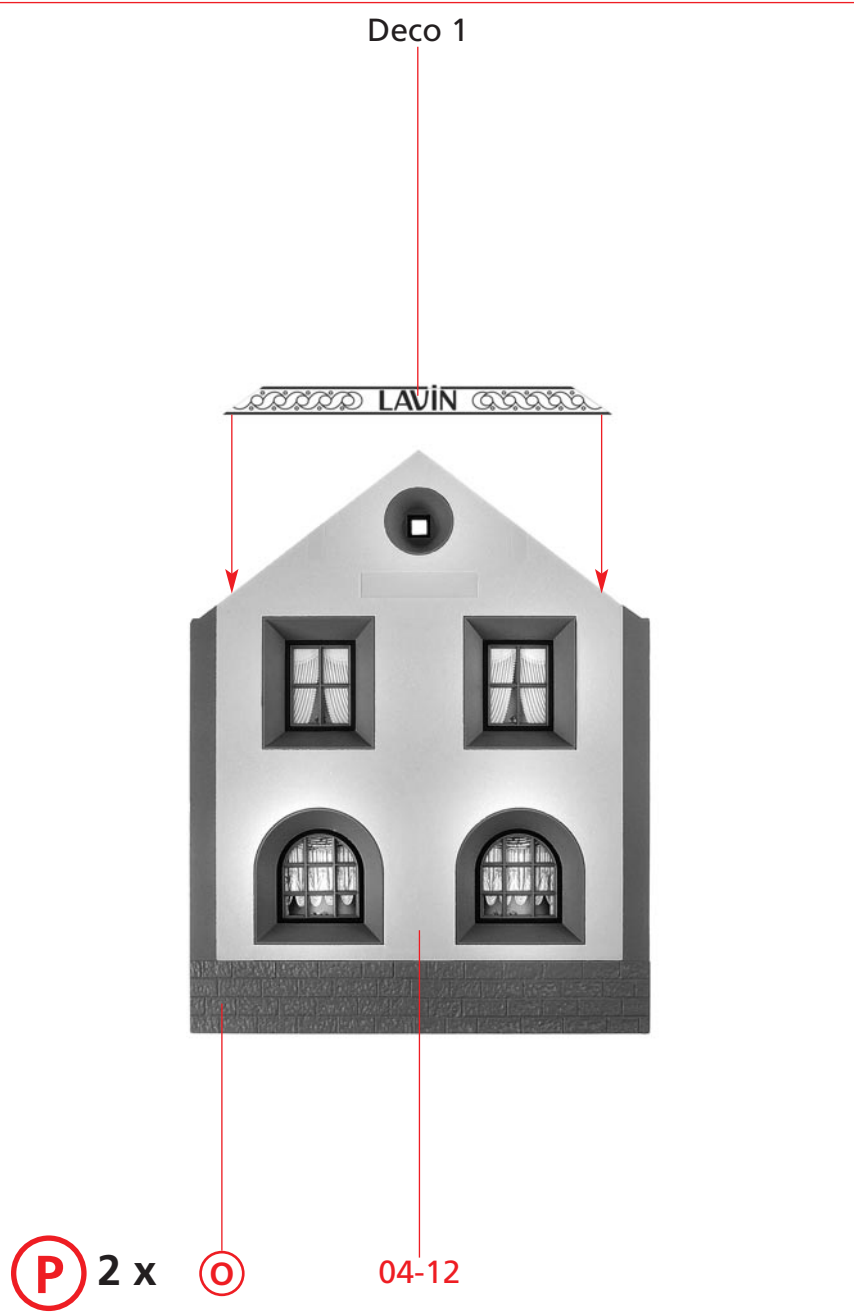
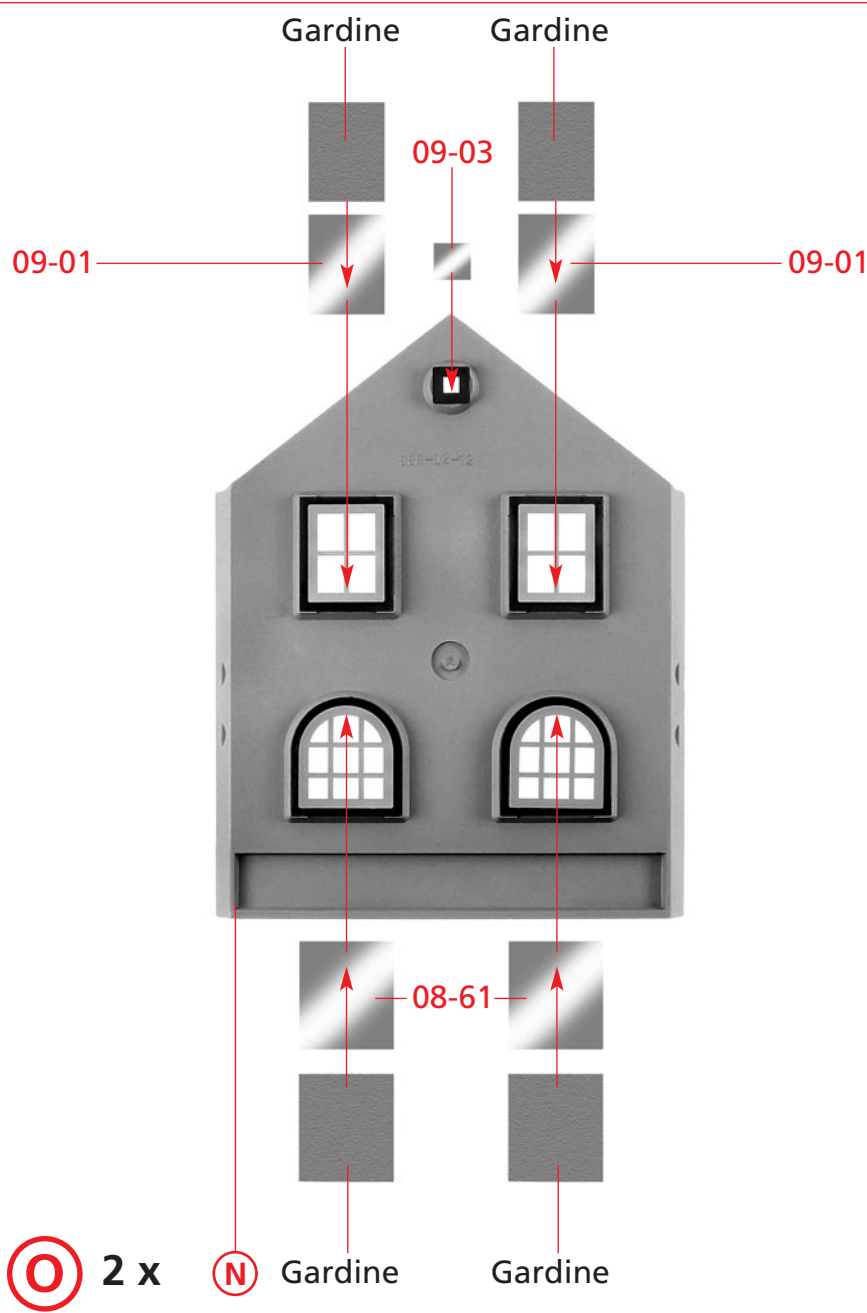
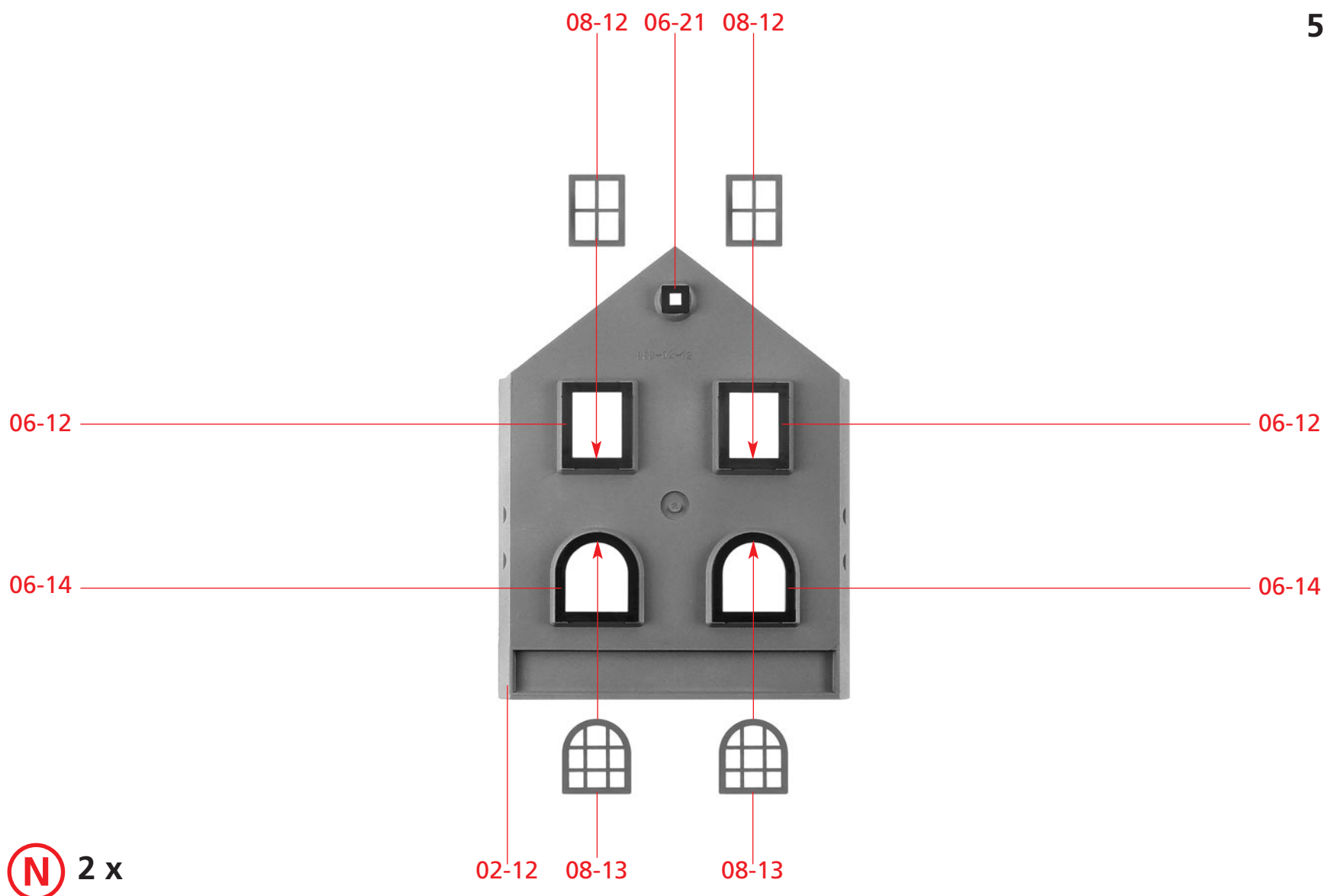

6

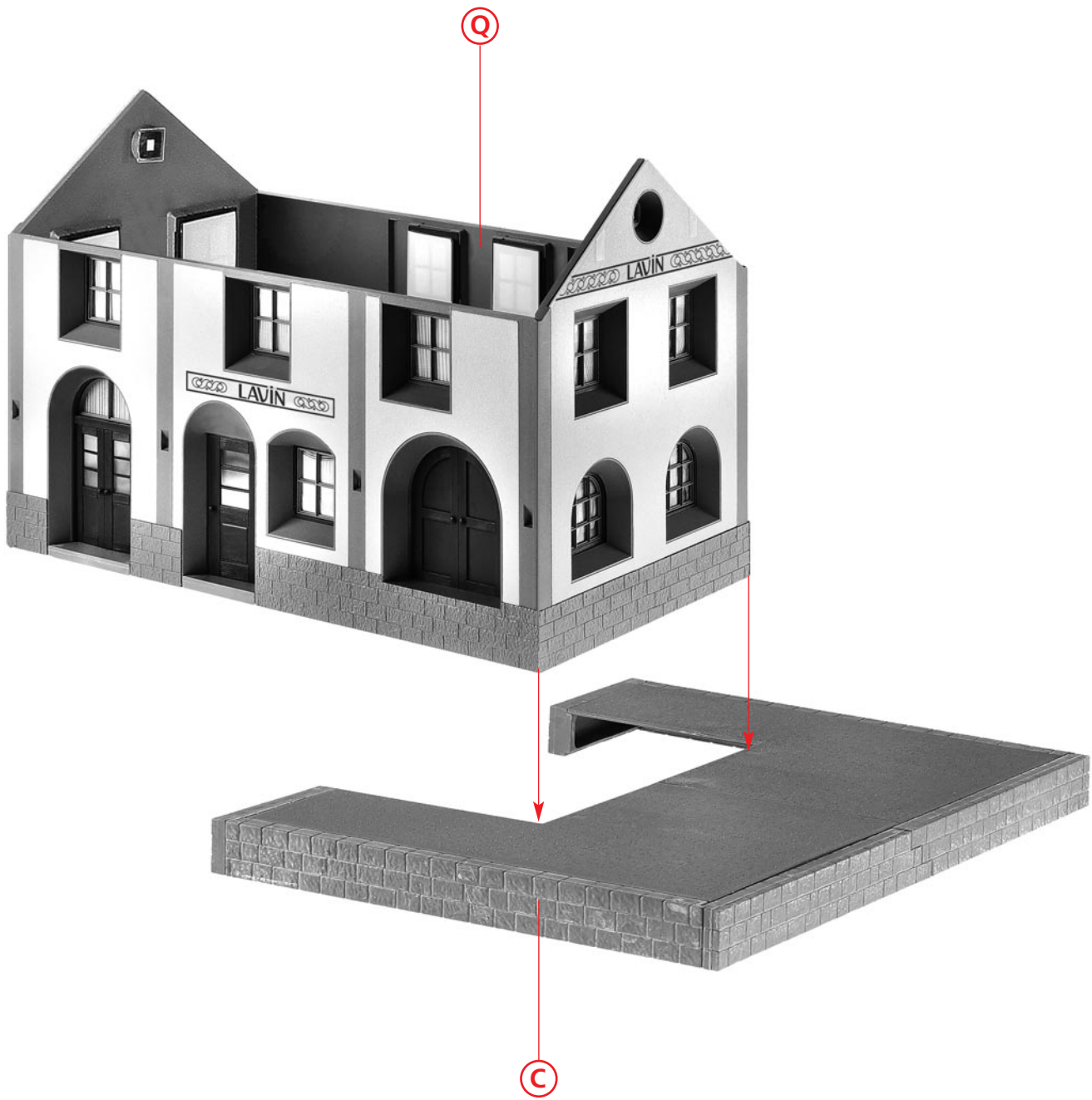
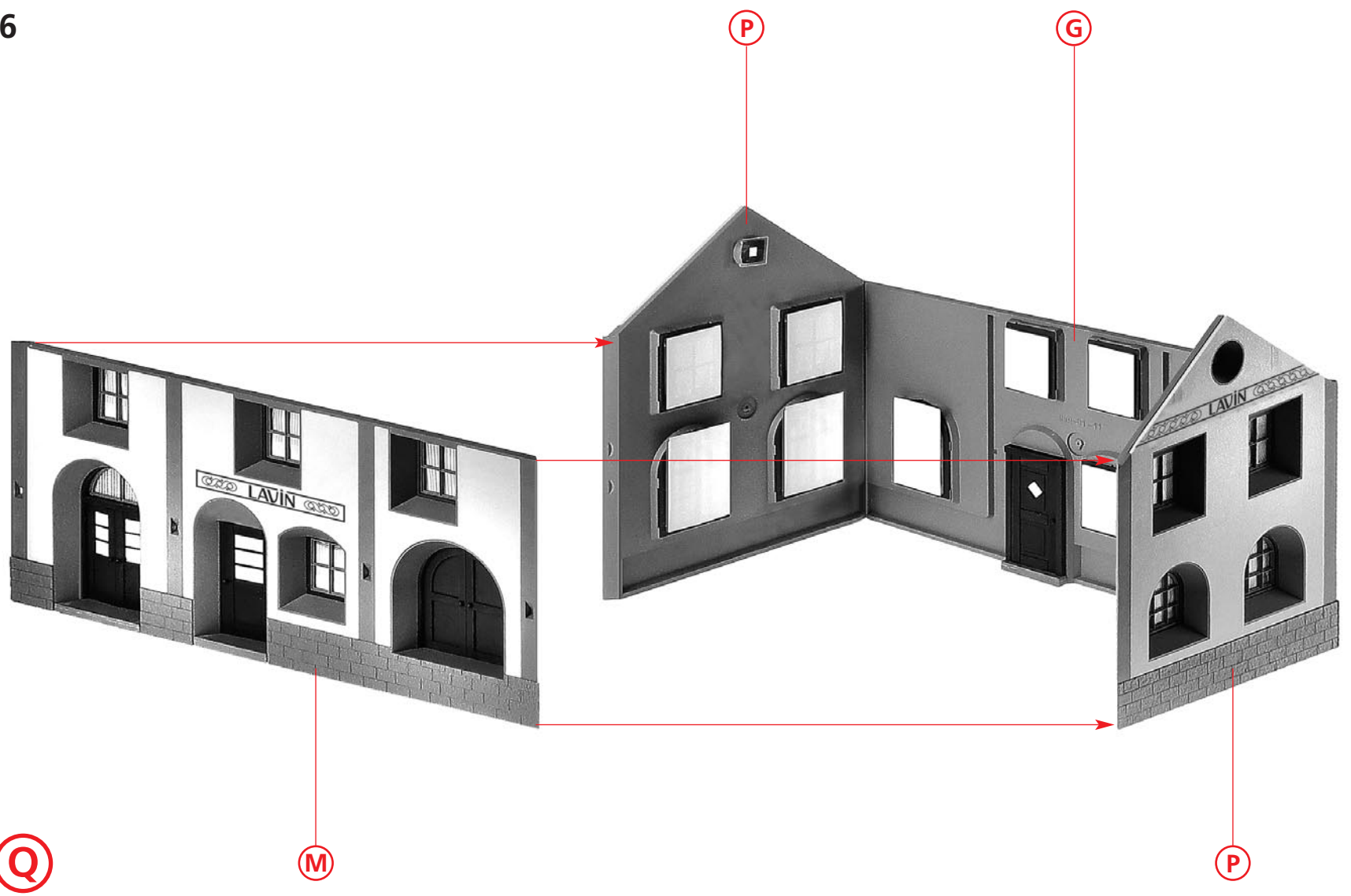

R

C

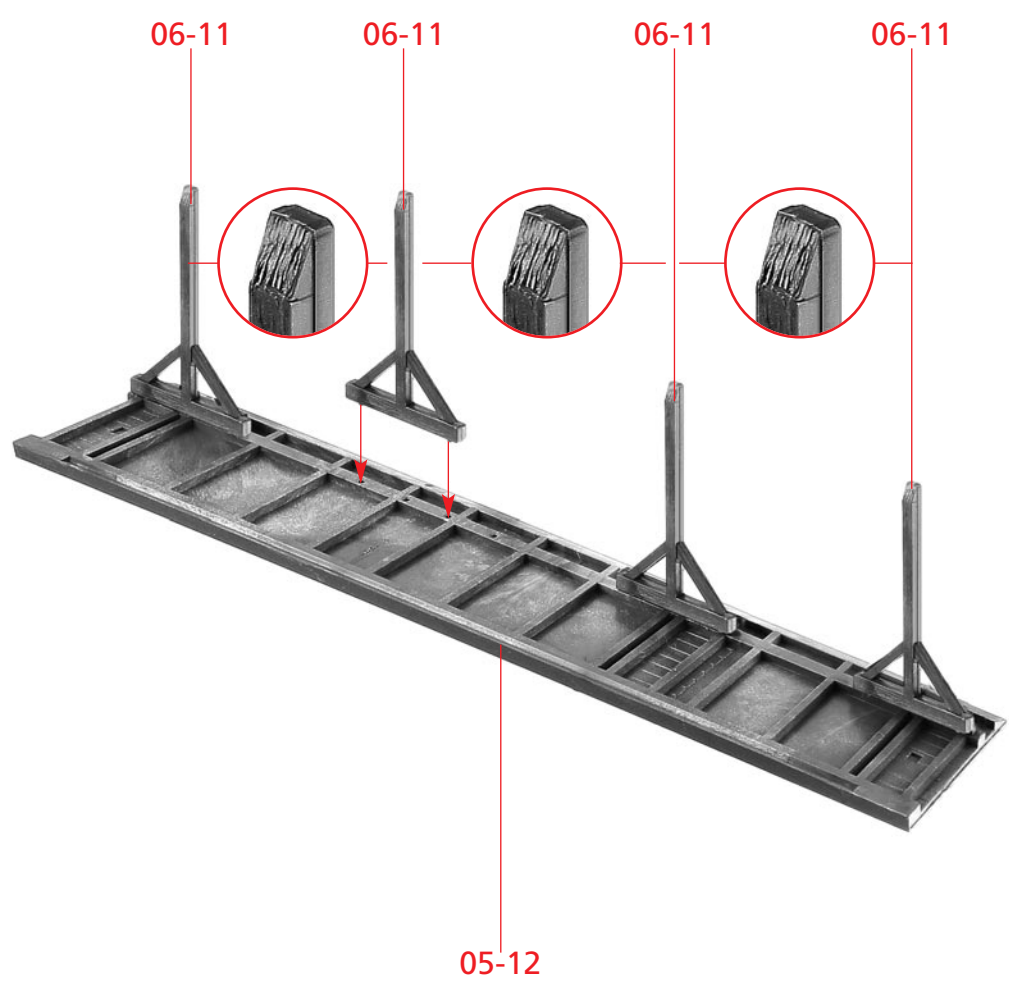

S 2 x

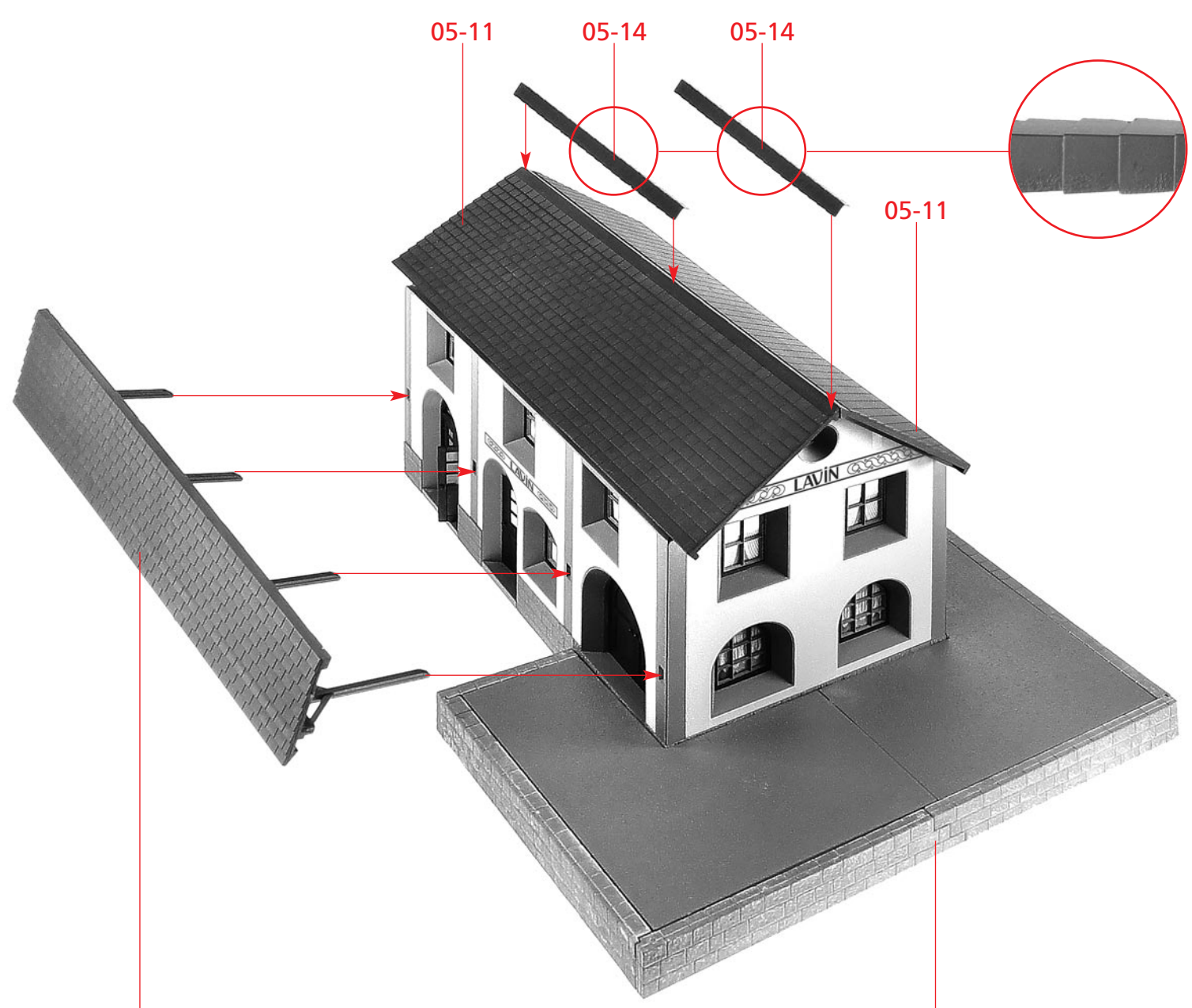

T

S

R

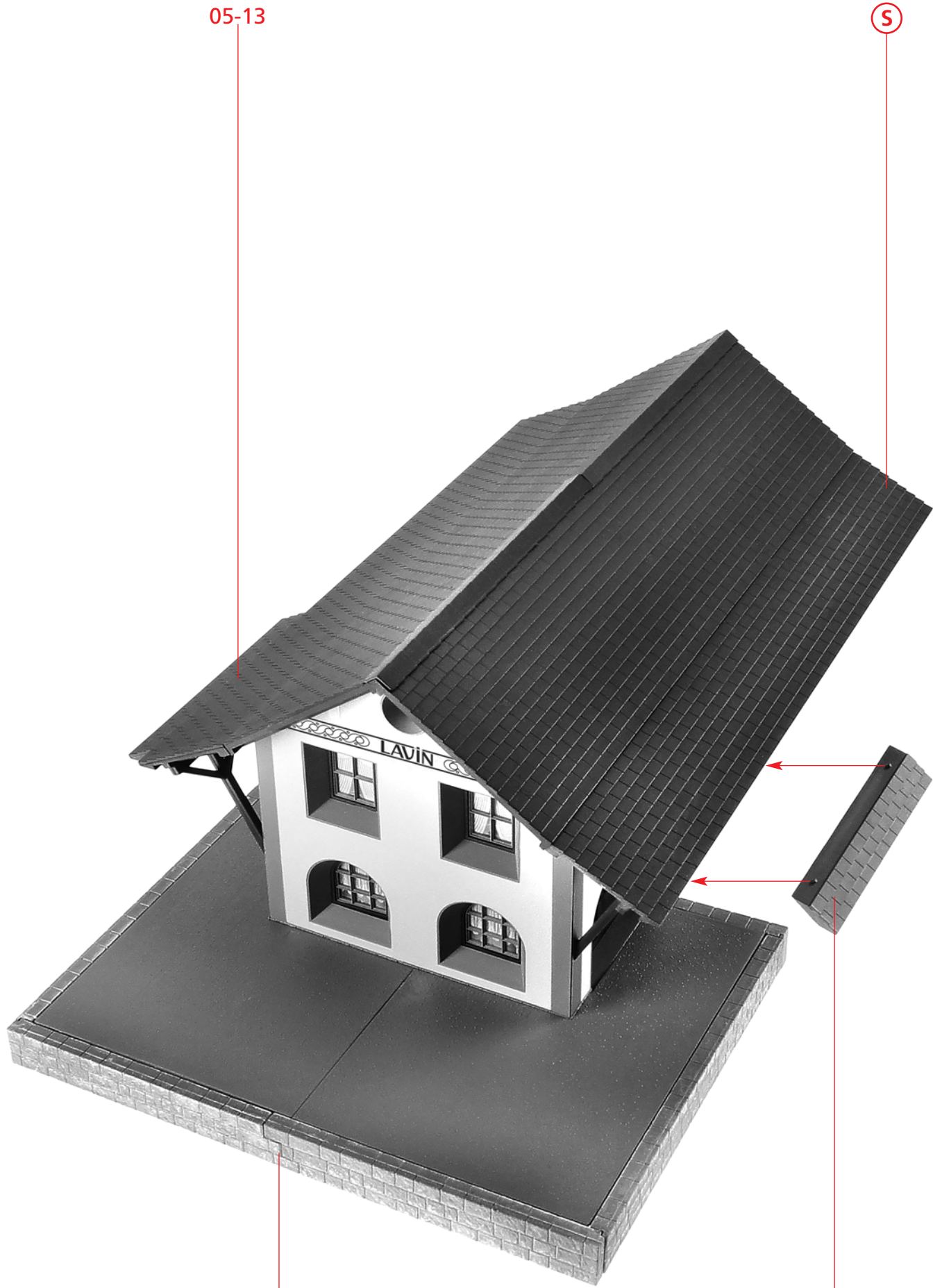

05-13

S

U

T

05-13

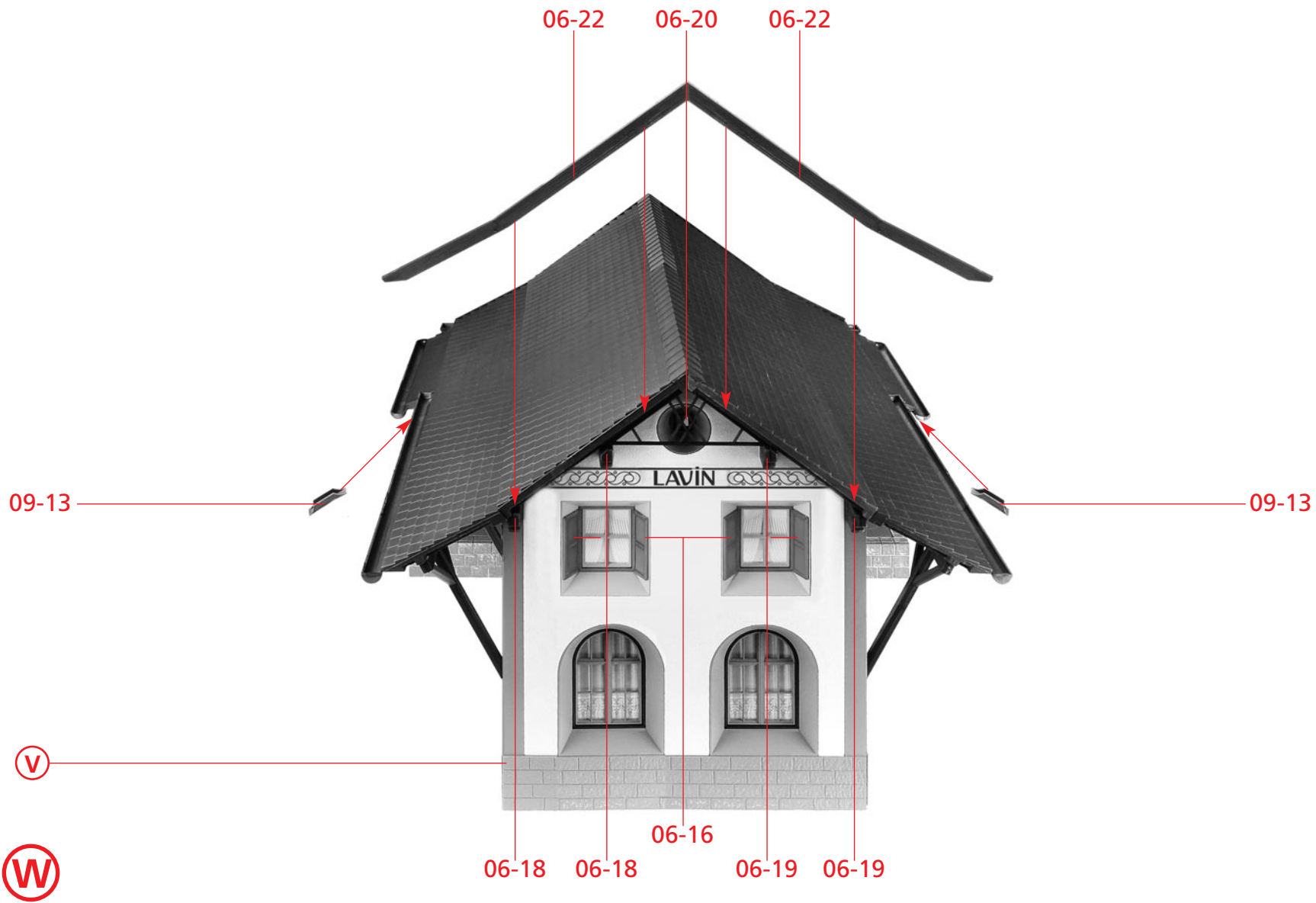
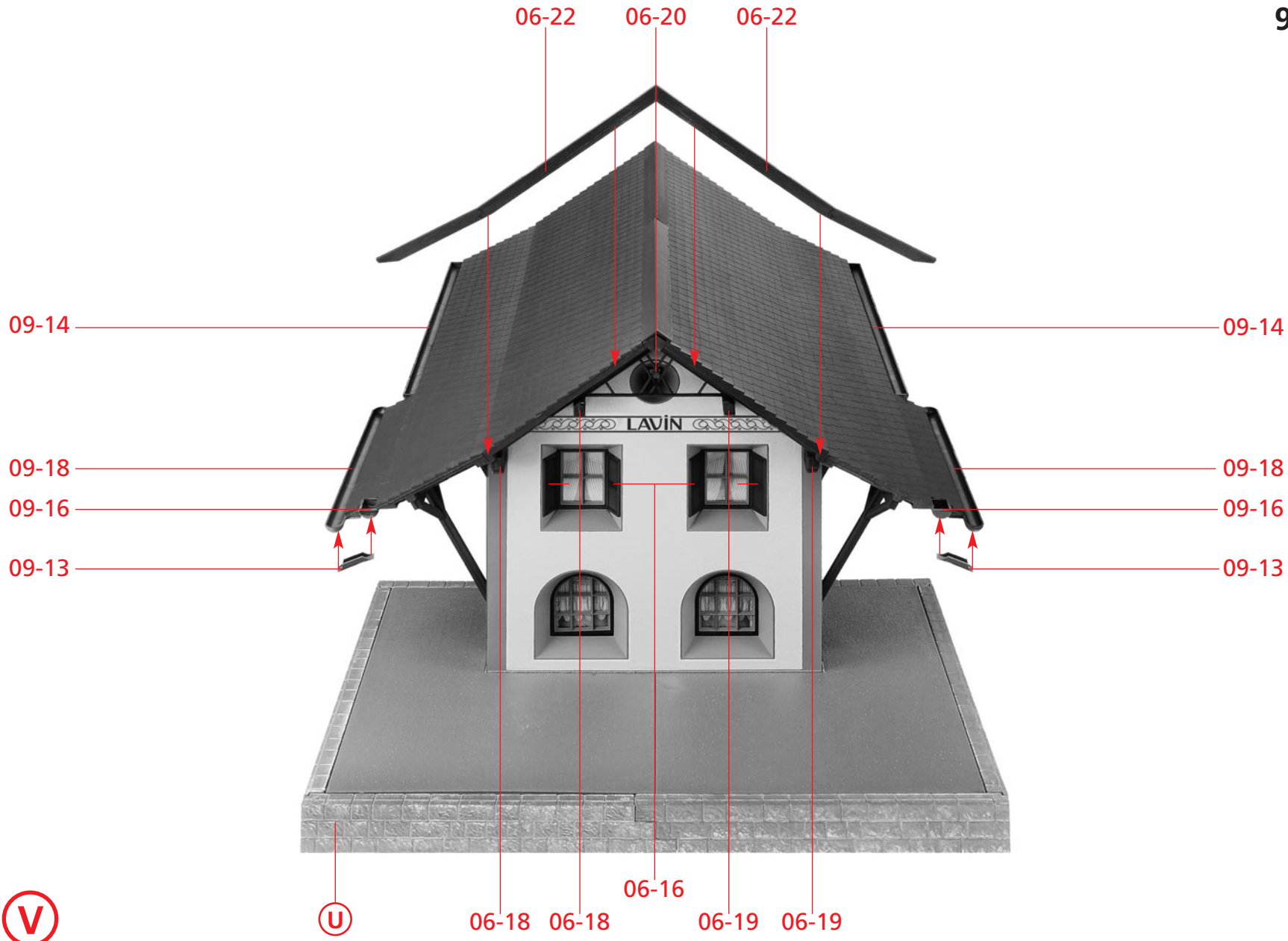

10

10-19 10-20 10-18

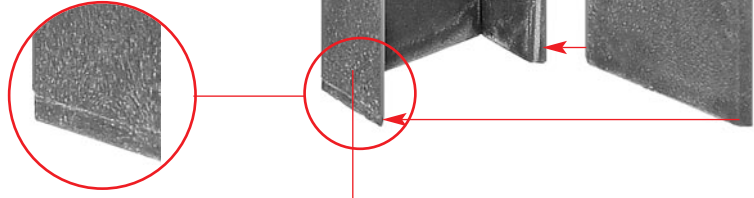

10-17

X

10-21

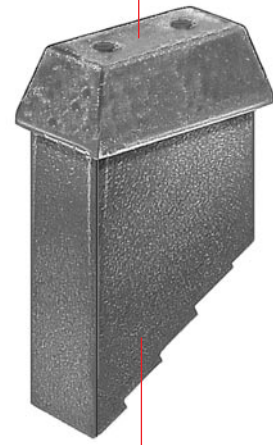

Y

X

06-23

Y

06-23

09-19



Z

W

06-24

09-20

06-17

Deco

Deco

PVC-Platte

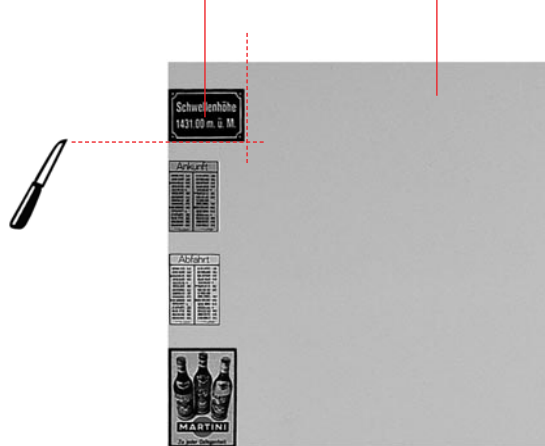

(a)

(b)

05-13

05-13

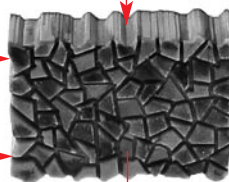
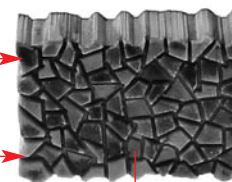
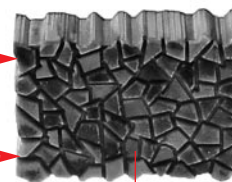
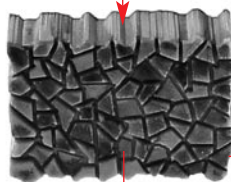
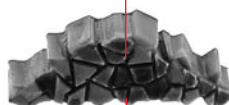
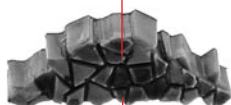

05-15

05-15

05-15

05-15

(c)

Inhalt	Tüte	Contents bag
Contenu	sachet	Inhoud zakje

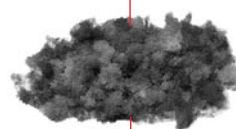

(d)

6 x

05-14

06-23

(b)

06-17

06-23

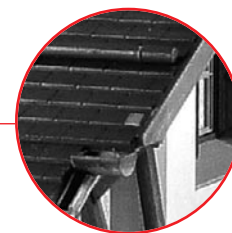
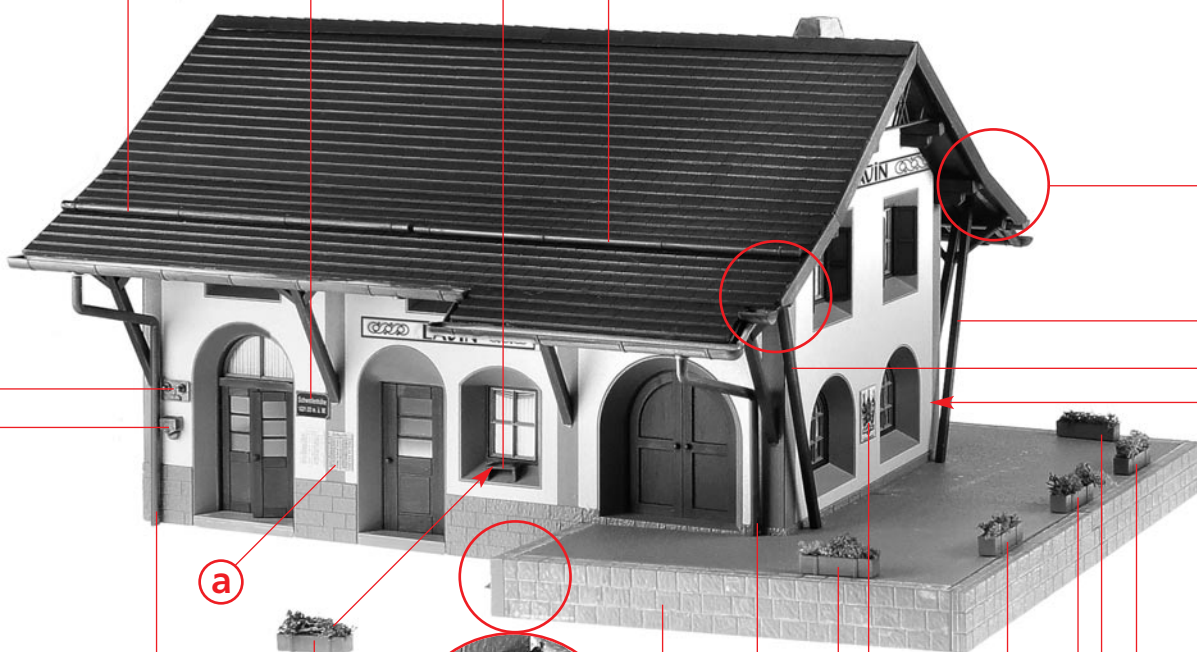

06-16

06-16

09-12

09-11

(a)

(b)

(e)

09-20

(d)

06-24

(Z)

09-19

(d)

(c)

