

märklin
H0

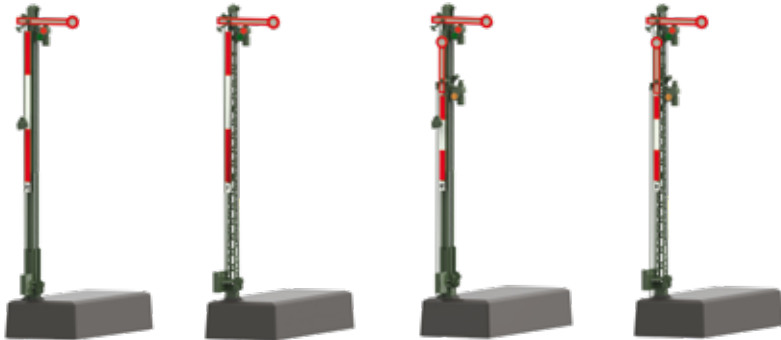

Hauptsignal
70391/70392/70411/70412

Inhaltsverzeichnis	Seite
Bestimmungsgemäße Verwendung	4
Lieferumfang	4
Sicherheitshinweise	4
Wichtige Hinweise	4
Technische Daten	4
Funktionen	4
Signal-Einbau	4
Programmierung mit CS 2 / CS3	5
Programmierung mit MS 2	5
Betrieb unter mfx	6
Betriebsart und Adressen einstellen	28
Aufbau	39
Aufkleber anbringen	48
Bohrschablone	49

Table of Contents	Page
Intended Use of the Product	7
Contents as Delivered	7
Safety Notes	7
Important Notes	7
Technical Data	7
Functions	7
Signal Installation	7
Programming with the CS 2 / CS3	8
Programming with the MS 2	8
Operation with mfx	9
Setting the mode of operation and addresses	28
Setup	39
Attach decals	48
Drilling Template	49

Sommaire	Page
Utilisation conforme	10
Livraison	10
Consignes de sécurité	10
Consignes importantes	10
Caractéristiques techniques	10
Fonctions	10
Montage du signal	10
Programmation avec CS 2 / CS3	11
Programmation avec MS 2	11
Exploitation sous mfx	12
Définir le mode d'exploitation et les adresses	28
Montage	39
Fixez les autocollants	48
Gabarit de perçage	49

Inhoudsopgave	Pagina
Beoogd gebruik	13
Leveringsomvang	13
Veiligheidsvoorschriften	13
Belangrijke aanwijzingen	13
Technische gegevens	13
Functies	13
Sein inbouwen	13
Programmeren met CS 2 / CS3	14
Programmeren met MS 2	14
Bedrijf met mfx	15
Bedrijfsmodus en adres instellen	28
Opbouwen	39
Bevestig stickers	48
Boorsjabloon	49

Índice	Página	Innehållsförteckning	Sidan
Uso previsto	16	Användningsområde	22
Alcance de suministro	16	Innehåll	22
Instrucciones de seguridad	16	Säkerhetsföreskrifter	22
Consejos importantes	16	Viktig information	22
Datos técnicos	16	Tekniska data	22
Funciones	16	Funktioner	22
Montaje de la señal	16	Signal-inbyggnad	23
Programación con CS 2 / CS3	17	Programmering med CS 2 / CS3	23
Programación con la MS 2	17	Programmering med MS 2	23
Funcionamiento en modo mfx	18	Körning med mfx	24
Configuración de modo de funcionamiento y direcciones	28	Ställ in driftstyp och adress	28
Montaje	39	Montering	39
Allega decalcomanie	48	Bifoga dekaler	48
Plantilla	49	Borrschablon	49

Elenco del contenido	Página	Indholdsfortegnelse	Side
Impiego commisurato alla destinazione	19	Hensigtsmæssig anvendelse	25
Corredo di forniture	19	Leveringsomfang	25
Avvertenze di sicurezza	19	Sikkerhedsvejledning	25
Avvertenze importanti	19	Vigtig information	25
Dati tecnici	19	Tekniske data	25
Funzioni	19	Funktioner	25
Montaggio del segnale	20	Signalindbygning	26
Programmazione con CS 2 / CS3	20	Programmering med CS 2 / CS3	26
Programmazione con MS 2	20	Programmering med MS 2	26
Esercizio sotto mfx	21	Drift med mfx	27
Impostate tipo di funzionamento e indirizzi	28	Indstil driftsart og adresser	28
Montaggio	39	Forsamling	39
Coloque las calcomanías	48	Vedhæft decals	48
Maschera di Foratura	49	Boreskabelon	49

Bestimmungsgemäße Verwendung

- Das Signal ist zum Einbau in H0 Digital-Modellbahn-Anlagen.
- Das Signal darf für den Analogbetrieb nur mit Stellpult 72760 verwendet werden.
- Darf nur in geschlossenen Räumen verwendet werden.

Lieferumfang

- 1 Signal
- 1 Kabel mit Stecker 2 polig, rot und braun
- 1 Kabel mit Stecker 3 polig, rot und rot
- 1 Kabel mit Stecker 3 polig, violett, rot-braun, rot-grün,
- 2 Haltewinkel zur Unterflurmontage
- 1 Halteplatte C-Gleis
- 4 Isolierungen (rot) C-Gleis (1Spritzling)
- 2 Mittelleiter-Isolierung (grau) K-Gleis
- 1 Mittelleiter-Anschluss K-Gleis
- 1 Schiebepbilder zur Kennzeichnung
- Einbauanleitung mit Schablone zur Unterflurmontage
- Garantieurkunde

Für die Unterflurmontage zusätzlich benötigtes Werkzeug: Schraubendreher, 4x Senkkopfschrauben Ø 2,5mm x (Länge abhängig von der Einbautiefe), Bohrer Ø 16mm und 2mm.

Sicherheitshinweise

- **ACHTUNG!** Funktionsbedingte scharfe Kanten und Spitzen.
- Verkabelungs- und Montagearbeiten nur im spannungslosen Zustand ausführen. Bei Nichtbeachtung kann es zu gefährlichen Körperströmen und damit zu Verletzungen führen.
- **Signal nur mit der zulässigen Spannung** (siehe technische Daten) **betreiben**.

Wichtige Hinweise

- Die Bedienungsanleitung ist Bestandteil des Produktes und muss deshalb aufbewahrt sowie bei Weitergabe des Produktes mitgegeben werden.
- Für Reparaturen wenden Sie sich bitte an Ihren Märklin-Fachhändler.
- Entsorgung: www.maerklin.com/en/imprint.html

Technische Daten

- Belastung ≤ 100 mA
- Belastung Gleis Ausgang max. 2 A
- Spannungsfestigkeit max. 40 V

Funktionen

- Multiprotokoll fähig: fx (MM), mfx und DCC
- Einstellen der Betriebsart mittels DIP-Schalter
- Einstellbare Adressen mit DIP-Schalter:
 - 1 – 256 fx (MM) (Control Unit 6021)
 - 1 – 320 fx (MM) (Central Station 6021x/Mobile Station 60653)
 - 1 – 511 (DCC)
- Programmierbare Adressen über CV
 - 1 – 2.040 DCC
- Änderungen der Eigenschaften über CV
- Stromversorgung über Digitalstromkreis

Signal-Einbau

Vor dem eigentlichen Einbau muss das Signal programmiert werden.

Folgende Arbeitsschritte dürfen nur im spannungslosen Zustand ausgeführt werden:

Einstellung der Adresse und Betriebsart durch den DIP-Schalter:

- Einstellen der Betriebsart mit DIP-Schalter 10
Schalter 10 off = fx (MM) / mfx
Schalter 10 on = DCC
- fx (MM)/DCC einstellen der Adresse mit DIP-Schalter (Tabelle ab Seite 28)

! Beachten Sie:

- Einstellungen mit dem DIP-Schalter immer spannungslos vornehmen. Das Signal erkennt erst mit dem Einschalten der Spannung die aktuellen Schalterstellungen.
- **Zum Schalten der Signale 70411 und 70412** werden grundsätzlich 2 Adressen (Tastenpaare) benötigt. Die 2. Adresse wird automatisch als Folgeadresse vergeben. Diese Folgeadresse **ist nicht frei wählbar**.

Programmierung mit CS 2 / CS 3

fx (MM)

Die CV Programmierung muss am Programmiergleis erfolgen. Es darf **immer nur ein Signal** am Programmiergleis angeschlossen werden.

Folgende CV können bei fx (MM) verändert werden: CV 39, 40, 41 und 42. Bei den CV 41 und 42 muss bei fx (MM) der Wert durch 4 geteilt werden, denn es sind nur Werte 0-80 zulässig z.B. $255/4 = 64$ (gerundet).

Während des Programmiervorganges blinkt die Signallampe, abweichend davon wird während des Programmierens mit der Central Station das Signal geschaltet. Nach Abschluss des Programmiervorganges wird das Signal auf „Fahrt“ gestellt.

Die Vorgehensweise beim Programmieren mit der Control Unit 6021 finden Sie auf www.maerklin.de -> Service -> Technische Informationen.

Die Programmierung mit anderen Geräten, entnehmen Sie bitte der Bedienungsanleitung des jeweiligen Steuergerätes.

DCC

Die CV Programmierung muss am Programmiergleis erfolgen. Es darf **immer nur ein Signal** am Programmiergleis angeschlossen werden. Während der Datenübertragung blinkt zur Kontrolle die Signallampe.

Die Programmierung mit anderen Geräten, entnehmen Sie bitte der Bedienungsanleitung des jeweiligen Steuergerätes.

Programmierung mit MS 2

Zur Programmierung der Signale mit der Mobile Station 2 muss eine neue Lokomotive manuell unter MM2 oder DCC angelegt werden.

Beachten Sie bitte, dass dann das zu programmierende Signal über die Codierschalter auch auf MM2 oder DCC und auf die selbe Adresse wie die Lokomotive eingestellt wurde. Diese neu angelegte Lokomotive wird nur für die Programmierung der Signale benötigt. Gehen Sie dazu im Menü der MS 2 auf „Lok konfigurieren“ und anschließend auf „CV programmieren“. Während des CV-programmierens dürfen keine anderen Lokomotiven, Signale oder Weichendecoder angeschlossen sein.

CV für fx (MM) und DCC

Unter fx (MM) kann die Adresse nur mit dem DIP-Schalter eingestellt werden. Werte in Klammern sind die Werkseinstellungen.

CV	Bedeutung	Werte	
1	Adresse 1 – 255	1-255 (1)	nur DCC
9	Adressen 256 – 2040	0-7 (0)	nur DCC
39 PoM*	Langsame Bewegung	0 (0)	
	Mittelschnelle Bewegung	1	
	Schnelle Bewegung	2	
	Mittelschnelle Bewegung mit Nachwippen	3	
	Schnelle Bewegung mit Nachwippen	4	
	Mittelschnelle Bewegung mit Nachwippen Flügel 1	5	nur bei 70411 / 70412
40 PoM*	Beleuchtung	0 – 15 (15)	0 Licht aus
			Dimmen 0-15, wobei 15 = 100% Helligkeit entspricht
41 PoM*	Mittelstellung Flügel 1	0 – 255	Einstellung der Mittelposition für den Flügel aller Signale
42 PoM*	Mittelstellung Flügel 2	0 – 255	nur bei 70411 / 70412 Einstellung der Mittelposition für den 2. Flügel



*PoM programmieren kann, sofern es vom Steuergerät unterstützt wird, am Hauptleis erfolgen.

Einstellen und errechnen der Adressen größer 255 (DCC):

Z.B. Adresse 1044 -> $1044:256=4,078125$. Der Wert vor dem Komma (4) ist in CV 9 einzutragen. Der Wert nach dem Komma (0,078125) wird mit 256 multipliziert $0,078125 \times 256=20$. Der errechnete Wert 20 muss in CV 1 eingetragen werden.

Betrieb unter mfx

Die mfx-Anmeldung kann unter MM oder DCC erfolgen. Entscheidend ist die über den Dip-Schalter 10 eingestellte Betriebsart.

Die mfx-Anmeldung wird mit der CS2 60213/60214/60215 in der Magnetartikelkonfiguration über  >  und mit der CS3 60216/60226 in der Magnetartikelkonfiguration über  > „mfx-Artikel suchen“ angestoßen.

Hinweis zur mfx-Anmeldung mit der CS2:

Auswahlmöglichkeit „Magnetartikel automatisch zuweisen“ unter „Setup“ >  > „Gleis“.

Ist dort das Häkchen gesetzt erfolgt die mfx-Anmeldung auf die ersten freien Adressen in der CS2. Ist das Häkchen nicht gesetzt, erfolgt die mfx-Anmeldung auf die tatsächlich am Decoder programmierten Adressen.

Intended Use of the Product

- This signal is for installation on HO digital model railroad layouts.
- This signal may only be used for analog operation with the 72760 control box.
- Use only in enclosed areas.

Contents as Delivered

- 1 Signal
- 1 Cable with plug, 2-conductor, red and brown
- 1 Cable with plug, 3-conductor, red and red
- 1 Cable with plug, 3-conductor, violet, red-brown, red-green
- 2 Mounting brackets for below-baseboard installation
- 1 Mounting for C Track
- 4 Insulator sleeves (red) for C track (1 sprue)
- 2 Center conductor insulators (gray) for K Track
- 1 Center conductor connector for K Track
- 1 Set of decals for identification
- Installation instructions with a template for below-baseboard installation
- Warranty card

Additional tools required for below-baseboard installation: screwdriver, 4 each countersunk screws Ø 2.5 mm x (length dependent on the installation depth), drills Ø 16 mm and 2 mm.

Safety Notes

- **IMPORTANT!** The product has sharp edges and points due to the way it works.
- Do wiring and installation work only when there is no voltage present. Failure to adhere to this may cause life-threatening current and injury.

- **This signal is to be operated only with the permissible voltage** (see technical data).

Important Notes

- The operating instructions are a component part of the product and must therefore be kept in a safe place as well as for transfer of the product to third parties.
- Please see your authorized Märklin specialty dealer for repairs.
- Disposing of the product: www.maerklin.com/en/imprint.html

Technical Data

- Load \leq 100 milliamps
- Load at the track output max. 2 amps
- Electrical strength max. 40 volts

Functions

- Capable of multi-protocols: fx (MM), mfx, and DCC
- Mode of operation set by means of DIP switches
- Addresses can be set by means of DIP switches:
 - 1 – 256 fx (MM) (Control Unit 6021)
 - 1 – 320 fx (MM) (Central Station 6021x/Mobile Station 60653)
 - 1 – 511 (DCC)
- Programmable addresses by means of CVs +1-2,040 DCC
- Characteristics can be changed by means of CVs
- Power supplied by means of the digital current circuit

Signal Installation

The signal must be programmed before actually installing it.

The following work steps may be done only when there is no voltage present:

Setting the address and the mode of operation with the DIP switches:

- Setting the mode of operation with DIP Switch 10
Switch 10 off = fx (MM) / mfx
Switch 10 on = DCC
- fx (MM)/DCC Setting the address with DIP switches (See table starting on Page 28)

! Please note:

- Always do settings with the DIP switches when there is no voltage present. The signal does not recognize the current switch settings until the voltage is turned on.
- Basically, 2 addresses (pairs of buttons) are required to **switch the 70411 and 70412 signals**. The second address is assigned automatically as a sequential address. This sequential address **cannot be selected at will**.

Programming with the CS 2 / CS 3

fx (MM)

The CV programming must be done on the programming track. **Only one signal** may be connected to the programming track **at a time**.

The following CVs can be changed in fx (MM): CV 39, 40, 41, and 42. With CVs 41 and 42 the value must be divided by 4 in fx (MM), because only the values 0-80 are allowed, for example:
 $255/4 = 64$ (rounded).

During the programming procedure, the signal light will blink. During programming with the Central Station, by contrast the signal is switched. After the end of the programming procedure, the signal is set at "Go".

The procedure for programming with the 6021 Control Unit

can be found at www.maerklin.de -> Service -> Technische Informationen.

Please see the operating instructions for the control devices in question for programming with other devices.

DCC

CV programming must be done on the programming track. **Only one signal** may be connected to the programming track **at a time**. The light on the signal will blink as a check during the data transmission.

Please see the operating instructions for the control devices in question for programming with other devices.

Programming with the MS 2

A new locomotive must be set up manually under MM2 or DCC in order to program signals with the Mobile Station 2.

Please note that the signal to be programmed is then also set by means of the coding switches to MM2 or DCC and to the same address as the locomotive. This newly set up locomotive is only required for the programming of signals. To do this go in the MS 2 menu to „Configure Locomotive“ and then to „Program CV“.

No other locomotive, signals, or turnout decoders may be connected while the CV(s) are being programmed.

CV for fx (MM) and DCC

With fx (MM) the address can be set only with the DIP switches. The values in parentheses are factory default settings.

CV	Meaning	Values	
1	Address 1 - 255	1-255 (1)	only DCC
9	Addresses 256 - 2040	0-7 (0)	only DCC

CV	Meaning	Values	
39	Slow movement	0 (0)	
PoM*	Medium fast movement	1	
	Fast movement	2	
	Medium fast movement with bouncing	3	
	Fast movement with bouncing	4	
	Medium fast movement with bouncing of Arm 1	5	only with 70411 / 70412
	Medium fast movement with bouncing of Arm 2	6	only with 70411 / 70412
40	Meaning Lighting	0 - 15 (15)	0 light off Dimming 0-15, whereby 15 = 100% brightness
PoM*			
41	Center setting for Arm 1	0 - 255	Setting of the middle position for the arm on all signals
PoM*			
42	Center setting for Arm 2	0 - 255	Only with 70411 / 70412 Setting of the middle position for the 2nd arm
PoM*			



*PoM programming can be done on the main track as long as it is supported by the control device.

Setting and Calculating Addresses Greater than 255 (DCC):

Example: Address 1044 -> $1044 : 256 = 4.078125$. The value before the decimal point (4) is entered in CV 9. The value after the decimal point (0.078125) is multiplied by 256 $0.078125 \times 256 = 20$. The calculated value of 20 must be entered in CV 1.

Operation with mfx

mfx registration can be done with MM or DCC. The mode of operation that has been set by means of Dip Switch 10 is critical.

The mfx registration is initiated with the 60213/60214/60215 CS2 in  >  and with the 60216/60226 CS3 in the solenoid item configuration by means of  > "search for mfx item".

Note about mfx registration with the CS2:

Selection possibility „Automatically assign solenoid item“ at „Setup“ >  > „Track“.

If the check mark there is checked, the mfx registration is done at the first open address in the CS2. If the check mark is not checked, the mfx registration is done at the address actually programmed on the decoder.

Utilisation conforme

- Le signal est conçu pour être monté sur des circuits ferroviaires miniatures numériques H0.
- Le signal ne doit être utilisé en mode analogue qu'avec un pupitre de commande 72760.
- Ne doit être utilisé que dans une pièce fermée.

Livraison

1 signal

1 câble avec prise bipolaire, rouge et marron

1 câble avec prise tripolaire, rouge et rouge

1 câble avec prise tripolaire, violet,rouge-brun, rouge-vert

2 équerres de fixation pour montage souterrain

1 plaque de maintien voie C

4 isolations (rouge) voie C (1 pièce moulée par injection)

2 isolations pour conducteur central (gris) voie K

1 connecteur pour conducteur central voie K

1 image à coulisser pour la signalisation

Instructions de montage avec schéma pour montage souterrain

Certificat de garantie

Outils supplémentaires requis pour le montage souterrain :

Tournevis, 4x vis à tête fraisée Ø 2,5mm x (la longueur dépendant de la profondeur de montage), perceuse Ø 16mm et 2mm.

Consignes de sécurité

- **ATTENTION !** Le matériel comporte des bords coupants et des pointes.
- Effectuer les travaux de câblage et de montage uniquement lorsque le circuit est hors tension. Dans le cas contraire, vous risquez de vous électrocuter et de vous blesser.

- **Utiliser le signal uniquement avec la tension autorisée** (cf. caractéristiques techniques).

Consignes importantes

- Le mode d'emploi fait partie intégrante du produit. Vous devez donc la conserver et la transmettre avec le produit.
- Pour les travaux de réparation, veuillez vous adresser à votre revendeur Märklin.
- Élimination : www.maerklin.com/en/imprint.html

Caractéristiques techniques

- Charge ≤ 100 mA
- Charge sortie voie max. 2 A
- Rigidité diélectrique max. 40 V

Fonctions

- Multiprotocole : fx (MM), mfx et DCC
- Réglage du mode de fonctionnement au moyen d'un interrupteur DIP
- Adresses réglables au moyen de l'interrupteur DIP:
 - 1 – 256 fx (MM) (Control Unit 6021)
 - 1 – 320 fx (MM) (Central Station 6021x/Mobile Station 60653)
 - 1 – 511 (DCC)
- Adresses programmables via CV
 - 1 – 2 040 DCC
- Modification des propriétés via CV
- Alimentation électrique via circuit électrique numérique

Montage du signal

Avant le montage à proprement parler, vous devez programmer le signal.

Vous réaliserez les étapes suivantes uniquement lorsque le circuit est hors tension :

Réglage de l'adresse et du mode de fonctionnement via l'interrupteur DIP :

- Réglage du mode de fonctionnement au moyen d'un interrupteur DIP 10
Interrupteur 10 off = fx (MM) / mfx
Interrupteur 10 on = DCC
- fx (MM)/DCC Réglage de l'adresse via l'interrupteur DIP (tableau à partir de la page 28)

! Attention :

- Effectuer les réglages via l'interrupteur DIP uniquement hors tension. Le signal reconnaît les positions du commutateur dès l'activation de la tension.
- **Pour commuter les signaux réf. 70411 et 70412**, deux adresses (paires de touches) sont en principe nécessaires. La 2^{de} adresse automatiquement attribuée est l'adresse consécutive. Cette adresse consécutive **ne peut pas être choisie librement**.

Programmation avec CS 2 / CS 3

fx (MM)

La programmation CV doit se faire au niveau de la voie de programmation. Vous ne devez brancher **qu'un seul signal** sur la voie de programmation.

Vous pouvez modifier les CV suivant dans fx (MM) : CV 39, 40, 41 et 42. Pour les CV 41 et 42 vous devez diviser la valeur de fx (MM) par 4 car seules des valeurs de 0-80 sont autorisées, par ex. $255/4 = 64$ (arrondie).

Pendant la programmation, la lampe du signal clignote, et, indépendamment de cela, le signal est couplé à la Central Station pendant la programmation. Une fois la procédure de programmation terminée, le signal est mis sur « circulation ».

Vous trouverez la procédure de programmation au moyen de la Control Unit 6021 à la page www.maerklin.de -> Service -> Technische Informationen (www.marklin.fr/fr/produits/outils/base_donnees_produits.html)

Pour la programmation avec d'autres appareils, veuillez consulter les modes d'emploi des pupitres de commande correspondant.

DCC

La programmation CV doit se faire au niveau de la voie de programmation. ne devez brancher **qu'un seul signal** sur la voie de programmation. Pendant la transmission des données, la lanterne du signal clignote.

Pour la programmation avec d'autres appareils, veuillez consulter les modes d'emploi des pupitres de commande correspondant.

Programmation avec MS 2

La programmation des signaux avec la Mobile Station 2 nécessite la création manuelle d'une nouvelle locomotive sous MM2 ou DCC. Veuillez tenir compte du fait que le signal à programmer aura alors été paramétré via les commutateurs de codage également sur MM2 ou DCC et sur la même adresse que la locomotive. Cette nouvelle locomotive créée est requise uniquement pour la programmation des signaux. A cet effet, allez dans le menu de la MS 2 sur « Configuration loco », puis sur « Programmation CV ». Pendant la programmation des CV, aucune autre locomotive ni

aucun autre signal ou décodeur d'aiguille ne doit être raccordé.

CV pour fx (MM) et DCC

Dans fx (MM), vous pouvez configurer l'adresse uniquement via l'interrupteur DIP. Les valeurs entre parenthèses sont les paramètres d'usine.

CV	Éclairage	Valeur	
1	Adresse 1 - 255	1-255 (1)	uniquement DCC
9	Adresses 256 - 2040	0-7 (0)	uniquement DCC
39	Mouvement lent	0 (0)	
PoM*	Mouvement de vitesse moyenne	1	
	Mouvement rapide	2	
	Mouvement de vitesse moyenne avec mouvement de ressort	3	
	Mouvement de vitesse rapide avec mouvement de ressort	4	
	Mouvement de vitesse moyenne avec mouvement de ressort aile 1	5	uniquement pour 70411 / 70412
	Mouvement de vitesse moyenne avec mouvement de ressort aile 2	6	uniquement pour 70411 / 70412
40	Éclairage	0 - 15 (15)	0 lumière éteinte variateur 0-15, 15 = 100% de luminosité
PoM*			
41	Réglage moyen aile 1	0 - 255	Réglage de la position moyenne pour l'aile de tous les signaux
PoM*			

CV	Éclairage	Valeur	
42	Réglage moyen aile 2	0 - 255	uniquement pour 70411 / 70412 réglage de la position moyenne pour la 2e aile
PoM*			

*Vous pouvez effectuer la programmation PoM, si elle est prise en charge par le pupitre de commande, sur la voie principale.



Réglage et calcul des adresses supérieures à 255 (DCC) :

Par ex. adresse 1044 -> $1044:256=4,078125$. Vous devez reporter la valeur avant la virgule (4) dans CV 9. Multipliez la valeur après la virgule (0,078125) par 256 $0,078125 \times 256=20$. Reportez la valeur calculée 20 dans CV 1.

Exploitation sous mfx

L'enregistrement mfx peut se faire sous MM ou DCC.

C'est le mode d'exploitation défini via le commutateur Dip 10 qui importe ici.

Avec la CS2 60213/60214/60215, l'enregistrement mfx est lancé dans la configuration des articles électromagnétiques via  >  et avec la CS3 60216/60226 dans la configuration des articles électromagnétiques via  > „Rechercher articles mfx“.

Remarque concernant la connexion mfx avec la CS2 :

Sélection possible „Affectation automatique d'un article électromagnétique“ sous „Configuration“ >  > „Voie“.

Si cette possibilité est cochée, l'enregistrement mfx se fait sur les premières adresses libres dans la CS2. Si cette possibilité n'est pas cochée, l'enregistrement mfx se fait sur les adresses réellement programmées sur le décodeur.

Beoogd gebruik

- Het sein is bestemd voor het inbouwen in H0-modelbanen.
- Het sein mag in analoogbedrijf alleen in combinatie met het schakelkastje 72760 gebruikt worden.
- Het mag alleen in gesloten ruimtes gebruikt worden.

Leveringsomvang

- 1 Sein
- 1 Kabel met stekker 2-polig rood en bruin
- 1 Kabel met stekker 3-polig rood en rood
- 1 Kabel met stekker 3-polig violet, rood-bruin, rood-groen
- 2 Hoekhouders voor ondervloermontage
- 1 houderplaat voor C-rail
- 4 Isolaties (rood) C-rail (1 gietstuk)
- 2 Middenrail isolaties (grijs) K-rail
- 1 Middenrail aansluiting K-rail
- 1 Transfer voor herkenning
- Inbouwaanwijzing met sjabloon voor ondervloermontage
- Garantiebewijs

Voor de ondervloermontage zijn daarnaast nog nodig: een schroevendraaier, 4 verzonken schroeven \varnothing 2mm x (lengte afhankelijk van de inbouwdiepte), boor \varnothing 16 mm en 2 mm.

Veiligheidsvoorschriften

- **LET OP!** Heeft vanwege de functionaliteit scherpe kanten en punten.
- Bedrading en montagewerkzaamheden alleen in spanningloze toestand uitvoeren. Als dit niet in acht genomen wordt kunt u gevaarlijke stroomschokken krijgen met de daarmee samenhangende verwondingen.

- **Het sein alleen met de toegelaten spanning** (zie technische gegevens) **gebruiken**.

Belangrijke aanwijzingen

- De gebruiksaanwijzing is een bestandsdeel van het product en dient daarom bewaard en meegegeven worden met het product.
- Voor reparaties kunt u zich tot uw Märklin dealer wenden.
- Verwijderingaanwijzing: www.maerklin.com/en/imprint.html

Technische gegevens

- Belasting \leq 100 mA
- Belasting railuitgang max. 2 A
- S-pinning max. 40 V

Functies

- Multi-protocol geschikt voor: fx (MM) , mfx en DCC
- Instellen van het bedrijfssysteem met dipschakelaar
- Instelbare adressen met dipschakelaars:
 - 1 – 256 fx (MM) (Control Unit 6021)
 - 1 – 320 fx (MM) (Central Station 6021x/ Mobile Station 60653)
 - 1 – 511 (DCC)
- Programmeerbare adressen via CV
 - 1 – 2040 DCC
- Veranderen van de eigenschappen via CV
- Stroomvoorziening via digitale stroomkring

Sein inbouwen

Voor het inbouwen moet het sein eerst geprogrammeerd worden.

De volgende werkzaamheden mogen alleen in spanningloze toestand worden uitgevoerd:

- Instellen van het adres en het bedrijfssysteem met dipschakelaar:
- Instellen van het bedrijfssysteem met dipschakelaar 10
Schakelaar 10 off = fx (MM) / mfx
Schakelaar 10 on = DCC
- fx (MM) / DCC instellen van het adres met dipschakelaar (tabel zie pagina 28)

! Let op:

- instelling met de dipschakelaar altijd in spanningloze toestand uitvoeren. Het sein herkent de actuele instelling pas na het inschakelen van de spanning.
- **Om de seinen 70411 en 70412** te kunnen schakelen zijn altijd 2 adressen (toetsenparen) nodig. Het 2de adres wordt automatisch als vervolgadres uitgegeven. Die vervolgadres **kan niet vrij gekozen** worden.

Programmeren met CS 2 / CS 3

fx (MM)

De CV programmering moet op het programmeerspoor worden uitgevoerd. Er mag **altijd maar één sein** op het programmeerspoor zijn aangesloten.

De volgende CV's kunnen bij fx (MM) veranderd worden: CV 39, 40, 41 en 42. Bij de CV's 41 en 42 moet bij fx (MM) de waarde door 4 worden gedeeld omdat alleen waarden van 0-80 toelaatbaar zijn, bijv. $255/4 = 64$ (afgerond).

Tijdens het programmeren knippert het licht van het sein, afwijkend daarvan wordt tijdens het programmeren met het Central Station het sein geschakeld. Na het afsluiten van het programmeren wordt het sein in de stand "veilig" gezet.

De werkwijze voor het programmeren met de Control Unit 6021 vindt u op www.maerklin.de -> Service -> Technische Informatie

De wijze van programmering met andere apparaten vindt u in de gebruiksaanwijzing van het desbetreffende apparaat.

DCC

De CV programmering moet op het programmeerspoor worden uitgevoerd. Er mag **altijd maar één sein** op het programmeerspoor zijn aangesloten. Tijdens de overdracht van de gegevens knippert het licht van het sein ter controle.

De wijze van programmering met andere apparaten vindt u in de gebruiksaanwijzing van het desbetreffende apparaat.

Programmeren met MS2

Voor het programmeren van seinen met het Mobile Station 2 moet, onder MM2 of DCC, handmatig een nieuwe locomotief ingevoerd worden.

Let er op dat het te programmeren sein met de codeerschakelaars ook op MM2 of DCC en op hetzelfde adres ingesteld staat als de locomotief. Deze nieuw ingevoerde locomotief wordt alleen gebruikt voor het programmeren van het sein. Ga hiervoor in het menu van het MS2 naar "loc configureren" en aansluitend naar "CV programmeren".

Tijdens het programmeren mogen geen andere locomotieven, seinen of wisseldecoders aangesloten zijn.

CV voor fx (MM) en DCC

Onder fx (MM) kan het adres alleen met de dipschakelaar worden ingesteld. De waarden tussen haakjes zijn de fabrieksinstellingen.

CV	Omschrijving	Waarde	
1	Adres 1 - 255	1-255 (1)	alleen DCC
9	Adres 256 - 2040	0-7 (0)	alleen DCC
39 PoM*	Langzaam bewegen	0 (0)	
	Middel snel bewegen	1	
	Snel bewegen	2	
	Middel snel bewegen met nawippen	3	
	Snel bewegen met nawippen	4	
	Middel snel bewegen met nawippen arm 1	5	Alleen bij 70411 / 70412
	Middel snel bewegen met nawippen arm 2	6	Alleen bij 70411 / 70412
40 PoM*	Verlichting	0 - 15 (15)	0=licht uit, dimmen 0-15 waarbij 15 = 100% helderheid
41 PoM*	Middenstand arm 1	0 - 255	Instelling van de middenstand van de arm van alle seinen
42 PoM*	Middenstand arm 2	0 - 255	Alleen bij 70411/70412 Instelling van de middenstand van de 2de arm

* PoM programmeren kan, voor zover het besturingsapparaat dit ondersteund, op het hoofdspoor gebeuren.

Instellen en berekenen van de adressen groter dan 255 (DCC):

Bijv. adres 144 -> 1044:256= 4,078125. De waarde voor de komma (4) moet in CV 9 ingevoerd worden. De waarde na de komma (0,078125) wordt met 256 vermenigvuldigd, 078125x256=20. De berekende waarde (20) wordt in CV 1 ingevoerd.

Bedrijf met mfx

De mfx aanmelding kan zowel onder MM als onder DCC gebeuren.

Bepalend daarvoor is het ingestelde bedrijfstype met dip-schakelaar 10.

De mfx aanmelding wordt met het CS2 60213/60214/60215 in de magneetartikel configuratie via  >  en met het CS3 60216/60226 in de magneetartikelen configuratie via  > "mfx-artikel zoeken" gestart.

Opmerking t.a.v. mfx aanmelding met het CS2

Keuzemogelijkheid "Magneetartikelen automatisch toewijzen" onder "Setup" >  "Rail".

Als daar het vinkje gezet is, vindt de mfx-aanmelding plaats op de eerste vrije adressen in het CS2. Is het vinkje niet gezet, dan vindt de mfx-aanmelding op het werkelijke, op de decoder geprogrammeerde adres plaats.

Uso previsto

- La señal ha sido concebida para su montaje en maquetas de trenes digitales H0.
- Está permitido utilizar la señal para funcionamiento analógico solo con el panel de mando 72760.
- Está permitido su uso solo en recintos cerrados.

Alcance de suministro

1 señal

1 cable con conector de 2 polos, rojo y marrón

1 cable con conector de 3 polos, rojo y rojo

1 cable con conector de 3 polos, violeta, rojo-marrón, rojo-verde

2 escuadras soporte para montaje bajo el suelo

1 placa soporte para vía C

4 aislamientos (rojo) para vía C (1 pieza inyectada)

2 aislamientos de conductor central (gris) para vía K

1 toma de conductor central para vía K

1 juego de indicadores deslizantes para identificación

Instrucciones de montaje con plantilla para montaje bajo el suelo.

Documento de garantía

Herramientas también necesarias para el montaje bajo el suelo: destornillador, 4 tornillos de cabeza avellanada Ø 2,5mm x (longitud en función de la profundidad de montaje), brocas de Ø 16 mm y 2 mm.

Instrucciones de seguridad

- ¡**ATENCIÓN!** Por su funcionalidad, incluye aristas cortantes y puntas.
- Realizar los trabajos de cableado y montaje siempre sin tensión eléctrica. En caso contrario, se pueden producir peligrosas corrientes a través del cuerpo y, por tanto, lesiones físicas.

- **Asegurar que la señal funcione solo a la tensión admisible** (ver Datos técnicos).

Consejos importantes

- Las instrucciones de empleo forman parte integrante del producto y, por este motivo, deben conservarse y entregarse al nuevo comprador en el caso de venta o transmisión del producto.
- Para las reparaciones, por favor diríjase a su distribuidor Märklin.
- Eliminación: www.maerklin.com/en/imprint.html

Datos técnicos

Carga admisible ≤ 100 mA

Carga de salida de vía máx. 2 A

Rigidez dieléctrica máx. 40 V

Funciones

- Apta para multiprotocolo: fx (MM), mfx y DCC
- Selección del modo de funcionamiento con microint. DIP
- Direcciones configurables con microint. DIP:
 - 1 – 256 fx (MM) (Control Unit 6021)
 - 1 – 320 fx (MM) (Central Station 6021x/Mobile Station 60653)
 - 1 – 511 (DCC)
- Direcciones programables vía CV
 - 1 – 2.040 DCC
- Modificaciones de las propiedades vía CV
- Alimentación eléctrica vía circuito digital

Montaje de la señal

Antes del montaje propiamente dicho, debe programarse la señal.

Está permitido ejecutar las siguientes operaciones únicamente sin tensión eléctrica:

Configuración de la dirección en el modo de funcionamiento mediante el microint. DIP:

- Configuración del modo de funcionamiento con microint. DIP 10
Microinterruptor 10 retirado = fx (MM) / mfx
Microinterruptor 10 colocado = DCC
- fx (MM)/DCC Configuración de la dirección con microint. DIP (Tabla a partir de página 28)

!Tenga presente lo siguiente:

- Realizar la configuración con el microint. DIP siempre sin tensión eléctrica. La señal no identifica las posiciones actuales del microinterruptor hasta que se activa la tensión.
- Por norma, **para conmutar las señales 70411 y 70412** se necesitan 2 direcciones (pares de teclas). La 2ª dirección se asigna automáticamente, siendo ésta la dirección siguiente. Esta dirección siguiente **no se puede seleccionar libremente.**

Programación con CS 2 / CS 3

fx (MM)

La programación de variables CV debe realizarse en la vía de programación. Está permitido conectar a la vía de programación **siempre solo una señal.**

En el modo fx (MM) pueden modificarse las siguientes CVs: CV 39, 40, 41 y 42. En las CV 41 y 42, en el modo fx (MM), el valor debe dividirse por 4 ya que están permitidos los valores 0-80, p. ej., $255/4 = 64$ (redondeado).

Durante la operación de programación, la lámpara de la señal destella y, a diferencia de ello, durante la operación de programación, la lámpara de la señal destella mientras que,

por el contrario, durante la programación con la Central Station la señal se conmuta. Una vez finalizada la programación, se cambia la señal a «Marcha».

Encontrará el procedimiento en la programación con la Control Unit 6021 en www.maerklin.de -> Service -> Technische Informationen.

Para realizar la programación con otras unidades de control, consulte su manual de instrucciones de empleo.

DCC

La programación de las CVs debe realizarse en la vía de programación. Está permitido conectar a la vía de programación **siempre solo una señal.** Durante la transmisión de datos, a modo de comprobación, luce el farol de la señal.

Para realizar la programación con otras unidades de control, consulte el manual de instrucciones de empleo de la unidad en cuestión.

Programación con la MS 2

Para programar las señales con la Mobile Station 2 se debe crear una locomotora nueva en MM2 o DCC.

En tal caso, asegúrese de que la señal a programar haya sido configurada, mediante los interruptores codificadores, también a MM2 o DCC y a la misma dirección que la locomotora. Esta locomotora nueva creada se necesita solo para la programación de las señales. Para ello, vaya a "Configurar locomotora" en el menú de la MS 2 " y seleccione "Programar CVs".

Durante la programación de las CVs no debe estar conectada ninguna otra locomotora, señal o decoder de desvío.

CV para fx (MM) y DCC

En fx (MM), es posible configurar la dirección solo con el micro-interruptor DIP. Los valores entre paréntesis representan la configuración de fábrica.

CV	Significado	Valores	
1	Dirección 1 - 255	1-255 (1)	solo DCC
9	Direcciones 256 - 2040	0-7 (0)	solo DCC
PoM*	Movimiento lento	0 (0)	
	Movimiento semirrápido	1	
	Movimiento semirrápido con rebasculación	2	
	Movimiento semirrápido con rebasculación	3	
	Movimiento rápido con rebasculación	4	
	Movimiento semirrápido con rebasculación de brazo 1	5	solo con 70411 / 70412
PoM*	Movimiento semirrápido con rebasculación de brazo 2	6	solo con 70411 / 70412
	Alumbrado	0 - 15 (15)	0 Luz apagada Regular intensidad a 0-15, en donde 15 equivale a brillo 100%
PoM*	Posición central brazo 1	0 - 255	Configuración de la posición central para el brazo de todas las señales

CV	Significado	Valores	
PoM*	42 Posición central brazo 2	0 - 255	solo en 70411 / 70412 Configuración de la posición central para el segundo brazo



*La programación en marcha PoM, siempre que así lo soporte la unidad de control, puede realizarse en la vía principal.

Configuración y cálculo de las direcciones mayores que 255 (DCC):

P. ej., dirección 1044 -> $1044:256=4,078125$. El valor antes de la coma (4) debe registrarse en la variable CV 9. El valor decimal (0.078125) se multiplica por 256 $0,078125 \times 256=20$. El valor calculado, 20, debe registrarse en la variable CV 1.

Funcionamiento en modo mfx

El inicio de sesión en mfx se puede realizar en modo MM o DCC. El modo de funcionamiento se selecciona con el microinterruptor DIP 10.

El inicio de sesión en modo mfx se inicia con la CS2 60213/60214/60215 en la configuración de artículos magnéticos a través de  >  y con la CS3 60216/60226 en la configuración de artículos magnéticos a través de  > "Buscar artículos mfx".

Nota sobre el inicio de sesión en mfx con la CS2:

Posibilidad de selección de „Asignar automáticamente artículos magnéticos” en „Setup (configuración)” >  > „Vía”.

Si en estas funciones se ha activado la marca de verificación, el inicio de sesión en modo mfx se realiza en las primeras direcciones libres de la CS2. Si no está activada la marca de verificación, el inicio de sesión en mfx se realiza en las direcciones realmente programadas en el decoder.

Impiego commisurato alla destinazione

- Tale segnale è da installare in impianti di ferrovia in miniatura H0 digitali.
- Per il funzionamento analogico tale segnale deve venire impiegato solo con il quadro di comando 72760.
- Deve venire utilizzato soltanto in ambienti chiusi.

Corredo di fornitura

1 segnale

1 cavetto con spina a 2 poli, rosso e marrone

1 cavetto con spina a 3 poli, rosso e rosso

1 cavetto con spina a 3 poli, violetto, rosso-marrone, rosso-verde

2 squadrette di supporto per montaggio sotto plancia

1 piastra di supporto per binario C

4 isolamenti (rossi) per binario C (1 pressofusione)

2 isolamenti per conduttore centrale (grigio) per binario K

1 connessione per conduttore centrale per binario K

1 figure trasferibili per identificazione

Istruzioni di montaggio con mascherina per montaggio sotto plancia

Certificato di garanzia

Per il montaggio sotto plancia, attrezzi aggiuntivi necessari: cacciavite, 4x viti a testa svasata Ø 2,5mm x (lunghezza dipendente dalla profondità di montaggio), punte da trapano Ø 16mm e 2mm.

Avvertenze di sicurezza

- **ATTENZIONE!** Bordi e spigoli acuminati per necessità funzionali.
- Eseguire i lavori di cablaggio e montaggio soltanto nelle condizioni di assenza di tensione. In caso di mancato rispetto, questo può portare a pericolose correnti corporee e pertanto a ferimenti.

- **Si faccia funzionare il segnale solamente con la tensione ammissibile** (si vedano i dati tecnici).

Avvertenze importanti

- Le istruzioni di impiego costituiscono parte integrante del prodotto e devono pertanto venire conservate con cura nonché consegnate insieme in caso di cessione a terzi del prodotto.
- Per riparazioni Vi preghiamo di rivolgerVi al Vostro rivenditore specialista Märklin.
- Smaltimento: www.maerklin.com/en/imprint.html

Dati tecnici

- Carico ≤ 100 mA
- Carico all'uscita per il binario max. 2 A
- Resistenza alla tensione max. 40 V

Funzioni

- Adatto a protocolli multipli: fx (MM), mfx e DCC
- Impostazione del tipo di esercizio a mezzo commutatore DIP
- Indirizzi impostabili con commutatore DIP:
 - 1 – 256 fx (MM) (Control Unit 6021)
 - 1 – 320 fx (MM) (Central Station 6021x/Mobile Station 60653)
 - 1 – 511 (DCC)
- Indirizzi programmabili tramite le CV
 - 1 – 2.040 DCC
- Variazioni delle caratteristiche tramite le CV
- Alimentazione di corrente tramite circuito di corrente digitale
- Illuminazione del segnale disattivabile oppure attivabile

Montaggio del segnale

Prima del vero e proprio montaggio il segnale deve venire programmato.

I seguenti passi del lavoro devono venire eseguiti soltanto nelle condizioni esenti da tensione:

Impostazione dell'indirizzo e del tipo di funzionamento mediante il commutatore DIP:

- Impostazione del tipo di funzionamento con commutatore DIP 10
Commutatore 10 off = fx (MM) / mfx
Commutatore 10 on = DCC
- fx (MM)/DCC impostazione dell'indirizzo con commutatore DIP (Tabella da pagina 28)

! Prestate attenzione:

- Intraprendere le impostazioni con il commutatore DIP-Schalter sempre senza tensione. Il segnale riconosce le disposizioni attuali del commutatore solo con l'accensione della tensione.
- **Per la commutazione dei segnali 70411 e 70412** vengono richiesti sostanzialmente 2 indirizzi (coppie di tasti). Il 2° indirizzo viene assegnato automaticamente come indirizzo successivo. Questo indirizzo successivo **non è selezionabile liberamente.**

Programmazione con CS 2 / CS 3

fx (MM)

La programmazione delle CV deve avvenire sul binario di programmazione. Al binario di programmazione deve venire collegato **sempre soltanto un segnale.**

Le seguenti CV possono venire modificate nel caso di fx (MM): CV 39, 40, 41 e 42. Nelle CV 41 e 42 in caso di fx (MM) il valore

deve venire diviso per 4, poiché sono consentiti valori 0-80, ad es. $255/4 = 64$ (arrotondato).

Durante la procedura di programmazione la luce del segnale lampeggia, in modo differente da ciò durante la programmazione con la Central Station il segnale è acceso. Dopo la conclusione del procedimento di programmazione il segnale viene disposto su „via libera“.

Il procedimento durante la programmazione con la Control Unit 6021 potete trovarlo su www.maerklin.de -> Service -> Technische Informationen.

La programmazione con altri apparati siete pregati di desumerla dalle istruzioni di azionamento del rispettivo apparato di controllo.

DCC

La programmazione delle CV deve avvenire sul binario di programmazione. Al binario di programmazione deve venire collegato **sempre soltanto un segnale.** Durante il trasferimento dei dati per controllo lampeggia il fanale sul segnale.

La programmazione con altri apparati siete pregati di desumerla dalle istruzioni di azionamento del rispettivo apparato di controllo.

Programmazione con MS 2

Per la programmazione dei segnali con la Mobile Station 2 deve venire definita manualmente una nuova locomotiva sotto MM2 oppure DCC. Si prega di prestare attenzione al fatto che poi anche il segnale da programmare mediante il commutatore di codifica sia stato impostato su MM2 oppure DCC, sullo stesso indirizzo come tale locomotiva. Questa locomotiva definita come nuova è necessaria soltanto per la programmazione del segnale. A tale scopo andate nel Menù della MS 2 su „Configurazione

loco” e successivamente su „Programmazione CV“. Durante tale programmazione delle CV non deve essere collegata alcuna altra locomotiva, segnale oppure Decoder per deviatore.

CV per fx (MM) e DCC

Sotto fx (MM) l’indirizzo può venire impostato solo con il commutatore DIP. I valore in parentesi sono le impostazioni di fabbrica.

CV	Significato	Valore	
1	Indirizzi 1 - 255	1-255 (1)	solo DCC
9	Indirizzi 256 - 2040	0-7 (0)	solo DCC
39 PoM*	Movimento lento	0 (0)	
	Movimento a media velocità	1	
	Movimento rapido	2	
	Movimento a media velocità con rimbalzo	3	
	Movimento rapido con rimbalzo	4	
	Movimento a media velocità con rimbalzo ala 1	5	solo nel caso 70411 / 70412
	Movimento a media velocità con rimbalzo ala 2	6	solo nel caso 70411 / 70412
40 PoM*	Illuminazione	0 - 15 (15)	0 luce spenta attenuazione 0-15, dove 15 = 100% uguale a luminosità
41 PoM*	Posizione media ala 1	0 - 255	Impostazione della posizione media per le ali di tutti i segnali

CV	Significato	Valore	
42 PoM*	Posizione media ala 2	0 - 255	solo nel caso 70411 / 70412 Impostazione della posizione media per la 2ª ala



*La programmazione PoM avviene sul binario principale, purché essa venga supportata all’apparato di comando.

Impostazione e calcolo degli indirizzi maggiori di 255 (DCC):

Ad es. indirizzo 1044 -> 1044:256=4,078125 . Il valore prima della virgola (4) viene inserito in CV 9. Il valore dopo la virgola (0,078125) viene moltiplicato per 256: 0,078125x256=20. Il valore calcolato 20 deve venire inserito nella CV 1.

Esercizio sotto mfx

La registrazione mfx può avvenire sotto MM oppure DCC. È discriminante il tipo di funzionamento impostato tramite il commutatore Dip 10.

La registrazione mfx viene avviata con la CS2 60213/60214/60215 nella configurazione degli apparati elettromagnetici tramite  >  e con la CS3 60216/60226 nella configurazione degli apparati elettromagnetici tramite  > „ricerca apparati mfx“.

Avvertenza sull’iscrizione mfx con la CS2:

Possibilità di selezione „Assegnare automaticamente apparati elettromagnetici“ sotto „Setup“ >  > „Binario“.

Se colà è posto il segno di spunta la registrazione mfx avviene sul primo indirizzo libero nella CS2. Se il segno di spunta non è collocato, la registrazione mfx avviene sull’indirizzo effettivamente programmato sul Decoder.

Användningsområde

- Signal avsedd för inbyggnad i digitala H0-modelljärnvägar.
- Vid analog drift får signalen endast användas tillsammans med ställpult nr 72760.
- Signalen får endast användas i torra utrymmen.

Innehåll

- 1 Signal
- 1 Kabel med 2-polig stickkontakt, röd och brun
- 1 Kabel med 3-polig stickkontakt, röd och röd
- 1 Kabel med 3-polig stickkontakt, violett, röd-brun, röd-grön
- 2 Vinkelhållare för montage under anläggningen
- 1 Fästesplatta för C-räls
- 4 Isoleringar (röda) för C-räls (1 sats m. 4 st)
- 2 Mittledar-isoleringar (grå) för K-räls
- 1 Mittledar-anslutning för K-räls
- 1 Dekal för uppmärkning
- 1 Bruksanvisning med schablon för montage på anläggningens undersida
- 1 Garantisedel

För montage på anläggningens undersida behöver man följande verktyg: Skruvmejsel, 4 X skruvar med försänkskalle \emptyset 2,5 mm x (längden beroende på underlagets tjocklek), borr med \emptyset 16 mm och \emptyset 2 mm.

Säkerhetsföreskrifter

- **WARNING!** Funktionsbetingade vassa kanter och spetsar.
- **OBS!** Risk för farliga elstötar och risk för kroppsskada! Infästning av kablar, elanslutningar och montage får därför endast göras i spänningslöst tillstånd.

- **Signalen får endast matas med tillåten/korrekt spänning!** (Se tekniska data i bruksanvisningen.)

Viktig information

- Bruksanvisningen är en del av denna produkt och måste därför sparas och den skall medfölja vid överlåtelse av produkten till tredje man.
- För ev. reparation måste man vända sig till sin Märklin-fackhandlare.
- För hantering som avfall v.g. se: www.maerklin.com/en/im-print.html

Tekniska data

- Belastning ≤ 100 mA
- Belastning spårutgång max. 2 A
- Spänning max. 40 V

Funktioner

- Anpassade för multiprotokoll:fx (MM), mfx och DCC
- Inställning av drifttyp görs med DIP-switchar
- Inställbara adresser med DIP-switchar:
 - 1 – 256 fx (MM) (ControlUnit 6021)
 - 1 – 320 fx (MM) (Central Station 6021x/Mobile Station 60653)
 - 1 – 511 (DCC)
- Programmerbara adresser via CV
 - 1 – 2.040 DCC
- Ändring av egenskaper via CV
- Strömförsörjning via den digitala strömkretsen

Signal-inbyggnad

Innan signalen byggs in/kopplas in i anläggningen måste den programmeras.

Följande arbetsmoment får endast utföras i spänningslöst tillstånd:

Inställning av adresser och drifttyp med DIP-switchar:

- Inställning av drifttyp med DIP-switch 10
Switch 10 off = fx (MM) / mfx
Switch 10 on = DCC
- fx (MM)/DCC inställning av adresser med DIP-switchar (tabeller på sidan 28)

! Observera:

- Inställningar med DIP-switchar får endast göras i spänningslöst tillstånd! Signalen visar den aktuella inställningen först efter att elspänningen anslutits.
- **För att reglera signalerna 70411 och 70412** fordras 2 adresser (knapp-par). Den 2:a adressen anges automatiskt som följeadress. Denna följeadress **är inte fritt valbar**.

Programmering med CS 2 / CS 3

fx (MM)

CV-programmering måste göras via programmeringsspåret.

OBS! Endast en enda signal i taget får anslutas till programmeringsspåret.

Följande CV kan ändras med fx (MM): CV 39, 40, 41 och 42. Betr. CV 41 och 42 måste med fx (MM) värdet delas med 4, eftersom värdena 0 - 80 finns tillgängliga, t.ex. $255/4 = 64$ (avrundat).

Under pågående programmering blinkar signalens lyktor, ev.

avvikelser under programmeringen kan ändras med Central Station. Efter avslutad programmering är signalen ställd på "kör".

Hur programmering genomförs med hjälp av Control Unit 6021 återfinns på www.maerklin.de -> Service -> Technische Informationen.

Vid programmering med andra körkontroller: V.g. se bruksanvisningen till respektive körkontroll.

DCC

CV-programmering måste göras via programmeringsspåret. **OBS! Endast en enda signal** i taget får anslutas till programmeringsspåret. Under pågående dataöverföring blinkar som bekräftelse signalens lyktor.

Vid programmering med andra körkontroller: V.g. se bruksanvisningen till respektive körkontroll.

Programmering med MS 2

För att programmera signalerna med Mobile Station 2 måste ett nytt lokomotiv skrivas in under MM2 eller DCC.

Observera då att signalen som ska programmeras ska via decodern kodas för MM2 eller DCC, samt på samma adress som loket ställts in på. Det nyinskrivna loket används bara för programmering av signalen. Gå därför in på MS 2-menyn, "konfigurerung av lok" och därefter på "CV-programmering". Under CV-programmeringen får inga andra lok, signaler eller växeldkodrar vara anslutna eller aktiverade.

CV för fx (MM) och DCC

under fx (MM) kan adresserna endast ställas in med DIP-switcharna. Angivna värden inom klammer är fabriksinställningar.

CV	Innebörd	Värde	
1	Adresser 1 - 255	1-255 (1)	endast DCC
9	Adresser 256 - 2040	0-7 (0)	endast DCC
39	Långsam rörelse	0 (0)	
PoM*	Medelsnabb rörelse	1	
	Snabb rörelse	2	
	Medelsnabb rörelse med omställning	3	
	Snabb rörelse med omställning	4	
	Medelsnabb rörelse med omställning vinge 1	5	endast för 70411 / 70412
	Medelsnabb rörelse med omställning vinge 2	6	endast för 70411 / 70412
40	Belysning	0 - 15 (15)	0 ljuset släckt dimmer 0-15, varvid 15 = 100% ljusstyrka
PoM*			
41	Mellanläge vinge 1	0 - 255	Inställning av mellanläge för samtliga signalers vingar
PoM*			
42	Mellanläge vinge 2	0 - 255	endast för 70411/70412 inställning av mellanläge för vinge 2
PoM*			

*PoM programmering kan, om körkontrollen tillåter detta, göras via anläggningens huvudspår.

Inställning och beräkning av adresser större än 255 (DCC):

T.ex. Adress 1044 -> $1044:256=4,078125$. Värdet efter komma-

tecknet (0,078125) multipliceras med 256 $0,078125 \times 256=20$. Det framräknade värdet måste tas in i CV 1.

Körning med mfx

Mfx-inställning kan göras med både MM och DCC.

Drifttyp ställs in med hjälp av dip-switch nr 10.

Mfx-inställningen görs med CS2 60213/60214/60215 i magnetartikelkonfigurationen via  > 

och med CS3 60216/60226 i magnetartikelkonfigurationen via  > "sökning av mfx-artiklar".

Information om mfx-inställning med CS2:

Valmöjlighet: "Automatisk tilldelning av magnetartikel" under "Setup" >  > "spår".

Om man markerar detta val så genomförs mfx-inställningen på den första lediga adressen i CS2. Om man inte markerar detta så genomförs mfx-inställningen på den adress som dekodern redan är inställd på.

Hensigtsmæssig anvendelse

- Signalet er til indbygning i H0 digital-modelbaneanlæg.
- Signalet må til analogdrift kun anvendes med kontrolpanel 72760.
- Må kun anvendes i lukkede rum.

Leveringsomfang

- 1 signal
- 1 kabel med stik, 2-polet, rød og brun
- 1 kabel med stik, 3-polet, rød og rød
- 1 kabel med stik, 3-polet, violet, rød-brun, rød-grøn
- 2 holdebeslag til underhængt montering
- 1 holdeplads C-skinne
- 4 isoleringer (rød) C-skinne (1støbt)
- 2 mellemløder-isoleringer (grå) K-skinne
- 1 mellemløder-tilslutning K-skinne
- 1 overføringsbillede til mærkning
- Indbygningsvejledning med skabelon til underhængt montering
- Garantibevis

Værktøj, der skal bruges til underhængt montering: Skruetrækker, 4x nedsænkningsskruer \varnothing 2,5 mm x (længden afhænger af indbygningsdybden), bor \varnothing 16 mm og 2mm.

Sikkerhedsvejledning

- **BEMÆRK!** Funktionsbetingede skarpe kanter og spidser.
- Kabel- og monteringsopgaver må udelukkende foretages i spændingsfri tilstand. Manglende overholdelse kan føre til farlig strøm gennem kroppen og skader.
- **Signalet må kun drives med den tilladte spænding** (se tekniske data).

Vigtig information

- Betjeningsvejledningen er del af produktet og skal derfor opbevares sammen med produktet og gives videre til tredjemand sammen med produktet.
- Kontakt din Märklin-forhandler for reparationer.
- Bortskaffelse: www.maerklin.com/en/imprint.html

Tekniske data

- Belastning \leq 100 mA
- Belastning skinneudgang maks. 2 A
- Holdespænding maks. 40 V

Funktioner

- Mulig multiprotokol: fx (MM), mfx og DCC
- Indstilling af driftsform ved hjælp af DIP-kontakt
- Indstilling af adresser ved hjælp af DIP-kontakt:
 - 1 – 256 fx (MM) (Control Unit 6021)
 - 1 – 320 fx (MM) (Central Station 6021x/Mobile Station 60653)
 - 1 – 511 (DCC)
- Programmérbare adresser via CV
 - 1 – 2.040 DCC
- Ændring af egenskaber via CV
- Strømforsyning via digitalstrømkreds

Signalindbygning

Signalet skal programmeres inden indbygning.

Følgende arbejdsstrin må kun udføres i spændingsfri tilstand:

Indstilling af adresser og driftsform via DIP-kontakten:

- Indstilling af driftsform ved hjælp af DIP-kontakt 10
Kontakt 10 off = fx (MM) / mfx
Kontakt 10 on = DCC
- fx (MM)/DCC indstilling af adresser med DIP-kontakt (tabel fra side 28)

! Bemærk:

- Indstillinger med DIP-kontakten skal altid foretages i spændingsfri tilstand. Signalet genkender først den aktuelle kontaktindstilling, når spændingen aktiveres.
- **Til forbindelse af signalerne 70411 og 70412** skal der grundlæggende altid bruges 2 adresser (tastepar). Den 2. adresse indstilles automatisk som følgeadresse. Følgeadressen **kan ikke vælges**.

Programmering med CS 2 / CS 3

fx (MM)

CV-programmeringen skal foretages på programmeringsskinen. Der må altid **kun tilsluttes et signal** på programmeringsskinen.

Følgende CV'er kan ændres ved fx (MM): CV 39, 40, 41 og 42. Ved CV 41 og 42, skal ved fx (MM) værdien deles med 4, for kun værdierne 0-80 er tilladte, f. eks. $255/4 = 64$ (afrundet).

Signallampen blinker under programmeringen; uafhængigt deraf aktiveres signalet med Central Station under programmeringen. Efter afsluttet programmering, indstilles signalet på „Kørsel“.

Fremgangsmåden til programmering med Control Unit 6021 findes på www.maerklin.de -> Service -> Technische Informationen.

Beskrivelse af programmeringen med andre enheder findes i betjeningsvejledningen for den pågældende styreenhed.

DCC

CV-programmeringen skal foretages på programmeringsskinen. Der må altid **kun tilsluttes et signal** på programmeringsskinen. Signalets lampe blinker til kontrol under hele dataoverførslen. Beskrivelse af programmeringen med andre enheder findes i betjeningsvejledningen for den pågældende styreenhed.

Programmering med MS 2

Til programmering af signalerne med Mobile Station 2 skal der oprettes et nyt lokomotiv manuelt under MM2 eller DCC. Bemærk venligst, at det programmerede signal over koderingskontakten så også bliver indstillet på MM2 eller DCC samt den samme adresse som lokomotivet. Det nyoprettede lokomotiv skal kun bruges til programmering af signalerne. Åbn dertil menuen på MS 2 og gå til "Konfiguration af lokomotiv" og derefter "Programmering af CV".

Der må ikke være tilsluttet andre lokomotiver, signaler eller sporskiftedekodere under CV-programmeringen.

CV til fx (MM) og DCC

Under fx (MM) kan adressen kun indstilles med DIP-kontakten. Værdier i parentes er fabriksindstillingerne.

CV	Betydning	Værdier	
1	Adresse 1 - 255	1-255 (1)	kun DCC
9	Adresser 256 - 2040	0-7 (0)	kun DCC

CV	Betydning	Værdier	
39	Langsom bevægelse	0 (0)	
PoM*	Mellemløbet bevægelse	1	
	Hurtig bevægelse	2	
	Mellemløbet bevægelse med eftervip	3	
	Hurtig bevægelse med eftervip	4	
	Mellemløbet bevægelse med eftervip Vinge 1	5	kun for 70411 / 70412
	Mellemløbet bevægelse med eftervip Vinge 2	6	kun for 70411 / 70412
40	Belysning	0 - 15 (15)	0 lys fra dimmer 0-15, hvor 15 = svarer til 100 % lys
PoM*			
41	Mellemstilling Vinge 1	0 - 255	Indstilling af mellemposition af alle signalers vinger
PoM*			
42	Mellemstilling Vinge 2	0 - 255	kun for 70411 / 70412 Indstilling af mellemposition for 2. vinge
PoM*			

*PoM kan programmeres på hovedskinnen, hvis det understøttes af styreenheden.



Indstilling og beregning af adresser større end 255 (DCC):

F. eks. adresse 1044 -> 1044:256=4,078125 . Værdien før komma (4) skal indtastes i CV 9. Værdien efter komma (0,078125) ganges med 256 (0,078125x256=20). Den beregnede værdi 20 indtastes i CV 1.

Drift med mfx

mfx-registreringen kan ske med MM eller DCC.

Den ved hjælp af dip-omskifter indstillede driftsmodus er afgørende.

mfx-registreringen indledes med CS2 60213/60214/60215 i magnetartikelkonfigurationen via  >  og med CS3 60216/60226 i magnetartikelkonfigurationen via  > „søg mfx-artikel“.

Vigtigt vedrørende mfx-registreringen med CS2:

Valgmulighed „tildel magnetartikel automatisk“ under „Setup“ >  > „Spor“.

Er fluebenet sat ved dette punkt, sker mfx-registreringen på de første frie adresser i CS2. Er fluebenet ikke sat ved dette punkt, sker mfx-registreringen på de effektivt ved dekoderen programmerede adresser.

Betriebsart und Adressen einstellen

Setting the mode of operation and addresses

Définir le mode d'exploitation et les adresses

Bedrijfsmodus en adres instellen

Configuración de modo de funcionamiento y direcciones

Impostate tipo di funzionamento e indirizzi



Ställ in driftstyp och adress



Indstil driftsart og adresser

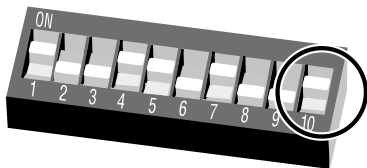

on = DCC



off = fx (MM)





										10 (0/1)
1	1	1	1						fx (MM)/DCC	
2	1	2	2						fx (MM)/DCC	
3	1	3	1	2					fx (MM)/DCC	
4	1	4		3					fx (MM)/DCC	
5	1	5	1	3					fx (MM)/DCC	
6	1	6		2	3				fx (MM)/DCC	
7	1	7	1	2	3				fx (MM)/DCC	
8	1	8			4				fx (MM)/DCC	
9	1	9	1		4				fx (MM)/DCC	
10	1	10		2	4				fx (MM)/DCC	
11	1	11	1	2	4				fx (MM)/DCC	
12	1	12		3	4				fx (MM)/DCC	
13	1	13	1	3	4				fx (MM)/DCC	
14	1	14		2	3	4			fx (MM)/DCC	
15	1	15	1	2	3	4			fx (MM)/DCC	
16	1	16				5			fx (MM)/DCC	
17	2	1	1			5			fx (MM)/DCC	
18	2	2		2		5			fx (MM)/DCC	
19	2	3	1	2		5			fx (MM)/DCC	
20	2	4			3	5			fx (MM)/DCC	
21	2	5	1		3	5			fx (MM)/DCC	
22	2	6		2	3	5			fx (MM)/DCC	
23	2	7	1	2	3	5			fx (MM)/DCC	
24	2	8			4	5			fx (MM)/DCC	
25	2	9	1		4	5			fx (MM)/DCC	
26	2	10		2	4	5			fx (MM)/DCC	

				10 (0/1)						
27		2	11	1	2	4	5	fx (MM)/DCC		
28		2	12			3	4	5	fx (MM)/DCC	
29		2	13	1		3	4	5	fx (MM)/DCC	
30		2	14			2	3	4	5	fx (MM)/DCC
31		2	15	1	2	3	4	5	fx (MM)/DCC	
32		2	16					6	fx (MM)/DCC	
33		3	1	1				6	fx (MM)/DCC	
34		3	2		2			6	fx (MM)/DCC	
35		3	3	1	2			6	fx (MM)/DCC	
36		3	4			3		6	fx (MM)/DCC	
37		3	5	1		3		6	fx (MM)/DCC	
38		3	6			2	3	6	fx (MM)/DCC	
39		3	7	1	2	3		6	fx (MM)/DCC	
40		3	8				4	6	fx (MM)/DCC	
41		3	9	1			4	6	fx (MM)/DCC	
42		3	10		2		4	6	fx (MM)/DCC	
43		3	11	1	2		4	6	fx (MM)/DCC	
44		3	12			3	4	6	fx (MM)/DCC	
45		3	13	1		3	4	6	fx (MM)/DCC	
46		3	14			2	3	4	6	fx (MM)/DCC
47		3	15	1	2	3	4	6	fx (MM)/DCC	
48		3	16					5	6	fx (MM)/DCC
49		4	1	1				5	6	fx (MM)/DCC
50		4	2		2			5	6	fx (MM)/DCC
51		4	3	1	2			5	6	fx (MM)/DCC



				10 (0/1)							
52		4	4			3	5	6	fx (MM)/DCC		
53		4	5	1		3	5	6	fx (MM)/DCC		
54		4	6		2	3	5	6	fx (MM)/DCC		
55		4	7	1	2	3	5	6	fx (MM)/DCC		
56		4	8				4	5	6	fx (MM)/DCC	
57		4	9	1			4	5	6	fx (MM)/DCC	
58		4	10		2		4	5	6	fx (MM)/DCC	
59		4	11	1	2		4	5	6	fx (MM)/DCC	
60		4	12			3	4	5	6	fx (MM)/DCC	
61		4	13	1		3	4	5	6	fx (MM)/DCC	
62		4	14			2	3	4	5	6	fx (MM)/DCC
63		4	15	1	2	3	4	5	6	fx (MM)/DCC	
64		4	16						7	fx (MM)/DCC	
65		5	1	1					7	fx (MM)/DCC	
66		5	2		2				7	fx (MM)/DCC	
67		5	3	1	2				7	fx (MM)/DCC	
68		5	4			3			7	fx (MM)/DCC	
69		5	5	1		3			7	fx (MM)/DCC	
70		5	6			2	3		7	fx (MM)/DCC	
71		5	7	1	2	3			7	fx (MM)/DCC	
72		5	8				4		7	fx (MM)/DCC	
73		5	9	1			4		7	fx (MM)/DCC	
74		5	10			2		4	7	fx (MM)/DCC	
75		5	11	1	2		4		7	fx (MM)/DCC	
76		5	12			3	4		7	fx (MM)/DCC	



										10 (0/1)
			1	2	3	4	5	6	7	
77	5	13	1		3	4			7	fx (MM)/DCC
78	5	14		2	3	4			7	fx (MM)/DCC
79	5	15	1	2	3	4			7	fx (MM)/DCC
80	5	16					5		7	fx (MM)/DCC
81	6	1	1				5		7	fx (MM)/DCC
82	6	2		2			5		7	fx (MM)/DCC
83	6	3	1	2			5		7	fx (MM)/DCC
84	6	4			3		5		7	fx (MM)/DCC
85	6	5	1		3		5		7	fx (MM)/DCC
86	6	6		2	3		5		7	fx (MM)/DCC
87	6	7	1	2	3		5		7	fx (MM)/DCC
88	6	8				4	5		7	fx (MM)/DCC
89	6	9	1			4	5		7	fx (MM)/DCC
90	6	10		2		4	5		7	fx (MM)/DCC
91	6	11	1	2		4	5		7	fx (MM)/DCC
92	6	12			3	4	5		7	fx (MM)/DCC
93	6	13	1		3	4	5		7	fx (MM)/DCC
94	6	14		2	3	4	5		7	fx (MM)/DCC
95	6	15	1	2	3	4	5		7	fx (MM)/DCC
96	6	16						6	7	fx (MM)/DCC
97	7	1	1					6	7	fx (MM)/DCC
98	7	2		2				6	7	fx (MM)/DCC
99	7	3	1	2				6	7	fx (MM)/DCC
100	7	4			3			6	7	fx (MM)/DCC
101	7	5	1		3			6	7	fx (MM)/DCC



										10 (0/1)	
			1	2	3	4	5	6	7		
102	7	6			2	3			6	7	fx (MM)/DCC
103	7	7	1	2	3				6	7	fx (MM)/DCC
104	7	8				4			6	7	fx (MM)/DCC
105	7	9	1			4			6	7	fx (MM)/DCC
106	7	10		2		4			6	7	fx (MM)/DCC
107	7	11	1	2		4			6	7	fx (MM)/DCC
108	7	12			3	4			6	7	fx (MM)/DCC
109	7	13	1		3	4			6	7	fx (MM)/DCC
110	7	14		2	3	4			6	7	fx (MM)/DCC
111	7	15	1	2	3	4			6	7	fx (MM)/DCC
112	7	16					5		6	7	fx (MM)/DCC
113	8	1	1				5		6	7	fx (MM)/DCC
114	8	2		2			5		6	7	fx (MM)/DCC
115	8	3	1	2			5		6	7	fx (MM)/DCC
116	8	4			3		5		6	7	fx (MM)/DCC
117	8	5	1		3		5		6	7	fx (MM)/DCC
118	8	6		2	3		5		6	7	fx (MM)/DCC
119	8	7	1	2	3		5		6	7	fx (MM)/DCC
120	8	8				4	5		6	7	fx (MM)/DCC
121	8	9	1			4	5		6	7	fx (MM)/DCC
122	8	10		2		4	5		6	7	fx (MM)/DCC
123	8	11	1	2		4	5		6	7	fx (MM)/DCC
124	8	12			3	4	5		6	7	fx (MM)/DCC
125	8	13	1		3	4	5		6	7	fx (MM)/DCC
126	8	14		2	3	4	5		6	7	fx (MM)/DCC
127	8	15	1	2	3	4	5		6	7	fx (MM)/DCC



128	01		ON							10 (0/1)	
	8	16	1	2	3	4	5	6	7		8
128	8	16								8	fx (MM)/DCC
129	9	1	1							8	fx (MM)/DCC
130	9	2		2						8	fx (MM)/DCC
131	9	3	1	2						8	fx (MM)/DCC
132	9	4			3					8	fx (MM)/DCC
133	9	5	1	3						8	fx (MM)/DCC
134	9	6		2	3					8	fx (MM)/DCC
135	9	7	1	2	3					8	fx (MM)/DCC
136	9	8				4				8	fx (MM)/DCC
137	9	9	1			4				8	fx (MM)/DCC
138	9	10		2		4				8	fx (MM)/DCC
139	9	11	1	2		4				8	fx (MM)/DCC
140	9	12			3	4				8	fx (MM)/DCC
141	9	13	1		3	4				8	fx (MM)/DCC
142	9	14		2	3	4				8	fx (MM)/DCC
143	9	15	1	2	3	4				8	fx (MM)/DCC
144	9	16					5			8	fx (MM)/DCC
145	10	1	1				5			8	fx (MM)/DCC
146	10	2		2			5			8	fx (MM)/DCC
147	10	3	1	2			5			8	fx (MM)/DCC
148	10	4			3		5			8	fx (MM)/DCC
149	10	5	1		3		5			8	fx (MM)/DCC
150	10	6		2	3		5			8	fx (MM)/DCC
151	10	7	1	2	3		5			8	fx (MM)/DCC
152	10	8				4	5			8	fx (MM)/DCC
153	10	9	1			4	5			8	fx (MM)/DCC

154	01		ON							10 (0/1)	
	10	10	1	2	3	4	5	6	7		8
154	10	10		2		4	5			8	fx (MM)/DCC
155	10	11	1	2		4	5			8	fx (MM)/DCC
156	10	12			3	4	5			8	fx (MM)/DCC
157	10	13	1		3	4	5			8	fx (MM)/DCC
158	10	14		2	3	4	5			8	fx (MM)/DCC
159	10	15	1	2	3	4	5			8	fx (MM)/DCC
160	10	16						6		8	fx (MM)/DCC
161	11	1	1					6		8	fx (MM)/DCC
162	11	2		2				6		8	fx (MM)/DCC
163	11	3	1	2				6		8	fx (MM)/DCC
164	11	4			3			6		8	fx (MM)/DCC
165	11	5	1		3			6		8	fx (MM)/DCC
166	11	6		2	3			6		8	fx (MM)/DCC
167	11	7	1	2	3			6		8	fx (MM)/DCC
168	11	8				4		6		8	fx (MM)/DCC
169	11	9	1			4		6		8	fx (MM)/DCC
170	11	10		2		4		6		8	fx (MM)/DCC
171	11	11	1	2		4		6		8	fx (MM)/DCC
172	11	12			3	4		6		8	fx (MM)/DCC
173	11	13	1		3	4		6		8	fx (MM)/DCC
174	11	14		2	3	4		6		8	fx (MM)/DCC
175	11	15	1	2	3	4		6		8	fx (MM)/DCC
176	11	16					5	6		8	fx (MM)/DCC
177	12	1	1				5	6		8	fx (MM)/DCC
178	12	2		2			5	6		8	fx (MM)/DCC
179	12	3	1	2			5	6		8	fx (MM)/DCC

										10 (0/1)
			1	2	3	4	5	6	7	
180		12 4			3	5 6	8		fx (MM)/DCC	
181		12 5	1		3	5 6	8		fx (MM)/DCC	
182		12 6		2 3		5 6	8		fx (MM)/DCC	
183		12 7	1 2 3			5 6	8		fx (MM)/DCC	
184		12 8			4 5 6	8			fx (MM)/DCC	
185		12 9	1		4 5 6	8			fx (MM)/DCC	
186		12 10		2	4 5 6	8			fx (MM)/DCC	
187		12 11	1 2		4 5 6	8			fx (MM)/DCC	
188		12 12			3 4 5 6	8			fx (MM)/DCC	
189		12 13	1		3 4 5 6	8			fx (MM)/DCC	
190		12 14		2 3 4 5 6	8				fx (MM)/DCC	
191		12 15	1 2 3 4 5 6	8					fx (MM)/DCC	
192		12 16					7 8		fx (MM)/DCC	
193		13 1	1				7 8		fx (MM)/DCC	
194		13 2		2			7 8		fx (MM)/DCC	
195		13 3	1 2				7 8		fx (MM)/DCC	
196		13 4			3		7 8		fx (MM)/DCC	
197		13 5	1 3				7 8		fx (MM)/DCC	
198		13 6		2 3			7 8		fx (MM)/DCC	
199		13 7	1 2 3				7 8		fx (MM)/DCC	
200		13 8			4		7 8		fx (MM)/DCC	
201		13 9	1		4		7 8		fx (MM)/DCC	
202		13 10		2	4		7 8		fx (MM)/DCC	
203		13 11	1 2		4		7 8		fx (MM)/DCC	
204		13 12			3 4		7 8		fx (MM)/DCC	
205		13 13	1		3 4		7 8		fx (MM)/DCC	



										10 (0/1)
			1	2	3	4	5	6	7	
206		13 14		2 3 4			7 8		fx (MM)/DCC	
207		13 15	1 2 3 4				7 8		fx (MM)/DCC	
208		13 16				5	7 8		fx (MM)/DCC	
209		14 1	1			5	7 8		fx (MM)/DCC	
210		14 2		2		5	7 8		fx (MM)/DCC	
211		14 3	1 2			5	7 8		fx (MM)/DCC	
212		14 4			3	5	7 8		fx (MM)/DCC	
213		14 5	1		3	5	7 8		fx (MM)/DCC	
214		14 6		2 3		5	7 8		fx (MM)/DCC	
215		14 7	1 2 3			5	7 8		fx (MM)/DCC	
216		14 8			4 5		7 8		fx (MM)/DCC	
217		14 9	1		4 5		7 8		fx (MM)/DCC	
218		14 10		2	4 5		7 8		fx (MM)/DCC	
219		14 11	1 2		4 5		7 8		fx (MM)/DCC	
220		14 12			3 4 5		7 8		fx (MM)/DCC	
221		14 13	1		3 4 5		7 8		fx (MM)/DCC	
222		14 14		2 3 4 5			7 8		fx (MM)/DCC	
223		14 15	1 2 3 4 5				7 8		fx (MM)/DCC	
224		14 16					6 7 8		fx (MM)/DCC	
225		15 1	1				6 7 8		fx (MM)/DCC	
226		15 2		2			6 7 8		fx (MM)/DCC	
227		15 3	1 2				6 7 8		fx (MM)/DCC	
228		15 4			3		6 7 8		fx (MM)/DCC	
229		15 5	1		3		6 7 8		fx (MM)/DCC	
230		15 6		2 3			6 7 8		fx (MM)/DCC	
231		15 7	1 2 3				6 7 8		fx (MM)/DCC	



				10 (0/1)								
232		15	8			4	6	7	8	fx (MM)/DCC		
233		15	9	1		4	6	7	8	fx (MM)/DCC		
234		15	10		2	4	6	7	8	fx (MM)/DCC		
235		15	11	1	2	4	6	7	8	fx (MM)/DCC		
236		15	12			3	4	6	7	8	fx (MM)/DCC	
237		15	13	1		3	4	6	7	8	fx (MM)/DCC	
238		15	14		2	3	4	6	7	8	fx (MM)/DCC	
239		15	15	1	2	3	4	6	7	8	fx (MM)/DCC	
240		15	16				5	6	7	8	fx (MM)/DCC	
241		16	1	1			5	6	7	8	fx (MM)/DCC	
242		16	2		2		5	6	7	8	fx (MM)/DCC	
243		16	3	1	2		5	6	7	8	fx (MM)/DCC	
244		16	4			3	5	6	7	8	fx (MM)/DCC	
245		16	5	1		3	5	6	7	8	fx (MM)/DCC	
246		16	6		2	3	5	6	7	8	fx (MM)/DCC	
247		16	7	1	2	3	5	6	7	8	fx (MM)/DCC	
248		16	8				4	5	6	7	8	fx (MM)/DCC
249		16	9	1			4	5	6	7	8	fx (MM)/DCC
250		16	10		2		4	5	6	7	8	fx (MM)/DCC
251		16	11	1	2		4	5	6	7	8	fx (MM)/DCC
252		16	12			3	4	5	6	7	8	fx (MM)/DCC
253		16	13	1		3	4	5	6	7	8	fx (MM)/DCC
254		16	14		2	3	4	5	6	7	8	fx (MM)/DCC
255		16	15	1	2	3	4	5	6	7	8	fx (MM)/DCC
256		16	16							9	fx (MM)/DCC	
257		17	1	1						9	fx (MM)/DCC	

				10 (0/1)							
258		17	2			2				9	fx (MM)/DCC
259		17	3	1	2					9	fx (MM)/DCC
260		17	4				3			9	fx (MM)/DCC
261		17	5	1		3				9	fx (MM)/DCC
262		17	6			2	3			9	fx (MM)/DCC
263		17	7	1	2	3				9	fx (MM)/DCC
264		17	8					4		9	fx (MM)/DCC
265		17	9	1				4		9	fx (MM)/DCC
266		17	10			2		4		9	fx (MM)/DCC
267		17	11	1	2			4		9	fx (MM)/DCC
268		17	12				3	4		9	fx (MM)/DCC
269		17	13	1		3	4			9	fx (MM)/DCC
270		17	14			2	3	4		9	fx (MM)/DCC
271		17	15	1	2	3	4			9	fx (MM)/DCC
272		17	16						5	9	fx (MM)/DCC
273		18	1	1					5	9	fx (MM)/DCC
274		18	2			2			5	9	fx (MM)/DCC
275		18	3	1	2				5	9	fx (MM)/DCC
276		18	4				3		5	9	fx (MM)/DCC
277		18	5	1		3			5	9	fx (MM)/DCC
278		18	6			2	3		5	9	fx (MM)/DCC
279		18	7	1	2	3			5	9	fx (MM)/DCC
280		18	8					4	5	9	fx (MM)/DCC
281		18	9	1				4	5	9	fx (MM)/DCC
282		18	10			2		4	5	9	fx (MM)/DCC
283		18	11	1	2			4	5	9	fx (MM)/DCC

		10 (0/1)									
		1	2	3	4	5	6	7	8	9	0
284	18	12			3	4	5			9	fx (MM)/DCC
285	18	13	1		3	4	5			9	fx (MM)/DCC
286	18	14		2	3	4	5			9	fx (MM)/DCC
287	18	15	1	2	3	4	5			9	fx (MM)/DCC
288	18	16						6		9	fx (MM)/DCC
289	19	1	1					6		9	fx (MM)/DCC
290	19	2		2				6		9	fx (MM)/DCC
291	19	3	1	2				6		9	fx (MM)/DCC
292	19	4			3			6		9	fx (MM)/DCC
293	19	5	1		3			6		9	fx (MM)/DCC
294	19	6		2	3			6		9	fx (MM)/DCC
295	19	7	1	2	3			6		9	fx (MM)/DCC
296	19	8			4	6		9		9	fx (MM)/DCC
297	19	9	1		4	6		9		9	fx (MM)/DCC
298	19	10		2	4	6		9		9	fx (MM)/DCC
299	19	11	1	2	4	6		9		9	fx (MM)/DCC
300	19	12			3	4	6			9	fx (MM)/DCC
301	19	13	1		3	4	6			9	fx (MM)/DCC
302	19	14		2	3	4	6			9	fx (MM)/DCC
303	19	15	1	2	3	4		6		9	fx (MM)/DCC
304	19	16					5	6		9	fx (MM)/DCC
305	20	1	1				5	6		9	fx (MM)/DCC
306	20	2		2			5	6		9	fx (MM)/DCC
307	20	3	1	2			5	6		9	fx (MM)/DCC
308	20	4			3		5	6		9	fx (MM)/DCC
309	20	5	1		3		5	6		9	fx (MM)/DCC



		10 (0/1)									
		1	2	3	4	5	6	7	8	9	0
310	20	6		2	3		5	6		9	fx (MM)/DCC
311	20	7	1	2	3		5	6		9	fx (MM)/DCC
312	20	8				4	5	6		9	fx (MM)/DCC
313	20	9	1			4	5	6		9	fx (MM)/DCC
314	20	10		2		4	5	6		9	fx (MM)/DCC
315	20	11	1	2		4	5	6		9	fx (MM)/DCC
316	20	12			3	4	5	6		9	fx (MM)/DCC
317	20	13	1		3	4	5	6		9	fx (MM)/DCC
318	20	14		2	3	4	5	6		9	fx (MM)/DCC
319	20	15	1	2	3	4	5	6		9	fx (MM)/DCC
320	20	16						7		9	fx (MM)/DCC
321	21	1	1					7	9		---/DCC
322	21	2		2				7	9		---/DCC
323	21	3	1	2				7	9		---/DCC
324	21	4			3			7	9		---/DCC
325	21	5	1		3			7	9		---/DCC
326	21	6		2	3			7	9		---/DCC
327	21	7	1	2	3			7	9		---/DCC
328	21	8				4		7	9		---/DCC
329	21	9	1			4		7	9		---/DCC
330	21	10		2		4		7	9		---/DCC
331	21	11	1	2		4		7	9		---/DCC
332	21	12			3	4		7	9		---/DCC
333	21	13	1		3	4		7	9		---/DCC
334	21	14		2	3	4		7	9		---/DCC
335	21	15	1	2	3	4		7	9		---/DCC



																					10 (0/1)																																																																																																																																																																																																																																																																																																																												
	336	21	16					5	7	9	---	/	DCC	337	22	1	1				5	7	9	---	/	DCC	338	22	2		2			5	7	9	---	/	DCC	339	22	3	1	2			5	7	9	---	/	DCC	340	22	4			3		5	7	9	---	/	DCC	341	22	5	1		3		5	7	9	---	/	DCC	342	22	6		2	3		5	7	9	---	/	DCC	343	22	7	1	2	3		5	7	9	---	/	DCC	344	22	8				4	5	7	9	---	/	DCC	345	22	9	1			4	5	7	9	---	/	DCC	346	22	10		2		4	5	7	9	---	/	DCC	347	22	11	1	2		4	5	7	9	---	/	DCC	348	22	12			3	4	5	7	9	---	/	DCC	349	22	13	1		3	4	5	7	9	---	/	DCC	350	22	14		2	3	4	5	7	9	---	/	DCC	351	22	15	1	2	3	4	5	7	9	---	/	DCC	352	22	16					6	7	9	---	/	DCC	353	23	1	1				6	7	9	---	/	DCC	354	23	2		2			6	7	9	---	/	DCC	355	23	3	1	2			6	7	9	---	/	DCC	356	23	4			3		6	7	9	---	/	DCC	357	23	5	1		3		6	7	9	---	/	DCC	358	23	6		2	3		6	7	9	---	/	DCC	359	23	7	1	2	3		6	7	9	---	/	DCC	360	23	8				4	6	7	9	---	/	DCC	361	23	9	1			4	6	7	9	---	/



																					10 (0/1)																																																																																																																																																																																																																																																																																																																																																							
	362	23	10					2	4	6	7	9	---	/	DCC	363	23	11	1	2			4	6	7	9	---	/	DCC	364	23	12			3	4	6	7	9	---	/	DCC	365	23	13	1		3	4	6	7	9	---	/	DCC	366	23	14		2	3	4	6	7	9	---	/	DCC	367	23	15	1	2	3	4	6	7	9	---	/	DCC	368	23	16					5	6	7	9	---	/	DCC	369	24	1	1				5	6	7	9	---	/	DCC	370	24	2		2			5	6	7	9	---	/	DCC	371	24	3	1	2			5	6	7	9	---	/	DCC	372	24	4			3		5	6	7	9	---	/	DCC	373	24	5	1		3		5	6	7	9	---	/	DCC	374	24	6		2	3		5	6	7	9	---	/	DCC	375	24	7	1	2	3		5	6	7	9	---	/	DCC	376	24	8				4	5	6	7	9	---	/	DCC	377	24	9	1			4	5	6	7	9	---	/	DCC	378	24	10		2		4	5	6	7	9	---	/	DCC	379	24	11	1	2		4	5	6	7	9	---	/	DCC	380	24	12			3	4	5	6	7	9	---	/	DCC	381	24	13	1		3	4	5	6	7	9	---	/	DCC	382	24	14		2	3	4	5	6	7	9	---	/	DCC	383	24	15	1	2	3	4	5	6	7	9	---	/	DCC	384	24	16								8	9	---	/	DCC	385	25	1	1							8	9	---	/	DCC	386	25	2		2						8	9	---	/	DCC	387	25	3	1	2						8	9	---	/

Key	Keyboard		ON										10 (0/1)			
	0	1	1	2	3	4	5	6	7	8	9	0	8	9	---	DCC
388	25	4			3								8	9	---	DCC
389	25	5	1		3								8	9	---	DCC
390	25	6		2	3								8	9	---	DCC
391	25	7	1	2	3								8	9	---	DCC
392	25	8				4							8	9	---	DCC
393	25	9	1			4							8	9	---	DCC
394	25	10		2		4							8	9	---	DCC
395	25	11	1	2		4							8	9	---	DCC
396	25	12			3	4							8	9	---	DCC
397	25	13	1		3	4							8	9	---	DCC
398	25	14		2	3	4							8	9	---	DCC
399	25	15	1	2	3	4							8	9	---	DCC
400	25	16					5						8	9	---	DCC
401	26	1	1				5						8	9	---	DCC
402	26	2		2			5						8	9	---	DCC
403	26	3	1	2			5						8	9	---	DCC
404	26	4			3		5						8	9	---	DCC
405	26	5	1		3		5						8	9	---	DCC
406	26	6		2	3		5						8	9	---	DCC
407	26	7	1	2	3		5						8	9	---	DCC
408	26	8				4	5						8	9	---	DCC
409	26	9	1			4	5						8	9	---	DCC
410	26	10		2		4	5						8	9	---	DCC
411	26	11	1	2		4	5						8	9	---	DCC
412	26	12			3	4	5						8	9	---	DCC
413	26	13	1		3	4	5						8	9	---	DCC

Key	Keyboard		ON										10 (0/1)								
	0	1	1	2	3	4	5	6	7	8	9	0	2	3	4	5	8	9	---	DCC	
414	26	14											2	3	4	5		8	9	---	DCC
415	26	15	1	2	3	4	5											8	9	---	DCC
416	26	16							6								6	8	9	---	DCC
417	27	1	1						6								6	8	9	---	DCC
418	27	2		2					6								6	8	9	---	DCC
419	27	3	1	2					6								6	8	9	---	DCC
420	27	4					3		6								6	8	9	---	DCC
421	27	5	1				3		6								6	8	9	---	DCC
422	27	6		2	3				6								6	8	9	---	DCC
423	27	7	1	2	3				6								6	8	9	---	DCC
424	27	8					4		6								6	8	9	---	DCC
425	27	9	1				4		6								6	8	9	---	DCC
426	27	10		2			4		6								6	8	9	---	DCC
427	27	11	1	2			4		6								6	8	9	---	DCC
428	27	12				3	4		6								6	8	9	---	DCC
429	27	13	1		3	4			6								6	8	9	---	DCC
430	27	14		2	3	4			6								6	8	9	---	DCC
431	27	15	1	2	3	4			6								6	8	9	---	DCC
432	27	16						5	6								6	8	9	---	DCC
433	28	1	1					5	6								6	8	9	---	DCC
434	28	2		2				5	6								6	8	9	---	DCC
435	28	3	1	2				5	6								6	8	9	---	DCC
436	28	4				3		5	6								6	8	9	---	DCC
437	28	5	1			3		5	6								6	8	9	---	DCC
438	28	6		2	3			5	6								6	8	9	---	DCC
439	28	7	1	2	3			5	6								6	8	9	---	DCC

													10 (0/1)
440		28 8				4 5 6		8 9	---/DCC				
441		28 9	1			4 5 6		8 9	---/DCC				
442		28 10		2		4 5 6		8 9	---/DCC				
443		28 11	1 2			4 5 6		8 9	---/DCC				
444		28 12			3	4 5 6		8 9	---/DCC				
445		28 13	1		3	4 5 6		8 9	---/DCC				
446		28 14		2	3	4 5 6		8 9	---/DCC				
447		28 15	1 2	3	4 5 6			8 9	---/DCC				
448		28 16						7 8 9	---/DCC				
449		29 1	1					7 8 9	---/DCC				
450		29 2		2				7 8 9	---/DCC				
451		29 3	1 2					7 8 9	---/DCC				
452		29 4			3			7 8 9	---/DCC				
453		29 5	1		3			7 8 9	---/DCC				
454		29 6		2	3			7 8 9	---/DCC				
455		29 7	1 2	3				7 8 9	---/DCC				
456		29 8			4			7 8 9	---/DCC				
457		29 9	1		4			7 8 9	---/DCC				
458		29 10		2	4			7 8 9	---/DCC				
459		29 11	1 2		4			7 8 9	---/DCC				
460		29 12			3	4		7 8 9	---/DCC				
461		29 13	1		3	4		7 8 9	---/DCC				
462		29 14		2	3	4		7 8 9	---/DCC				
463		29 15	1 2	3	4			7 8 9	---/DCC				
464		29 16				5		7 8 9	---/DCC				
465		30 1	1			5		7 8 9	---/DCC				

													10 (0/1)
466		30 2		2			5	7 8 9	---/DCC				
467		30 3	1 2				5	7 8 9	---/DCC				
468		30 4			3		5	7 8 9	---/DCC				
469		30 5	1		3		5	7 8 9	---/DCC				
470		30 6		2	3		5	7 8 9	---/DCC				
471		30 7	1 2	3			5	7 8 9	---/DCC				
472		30 8				4 5		7 8 9	---/DCC				
473		30 9	1			4 5		7 8 9	---/DCC				
474		30 10		2		4 5		7 8 9	---/DCC				
475		30 11	1 2			4 5		7 8 9	---/DCC				
476		30 12			3	4 5		7 8 9	---/DCC				
477		30 13	1		3	4 5		7 8 9	---/DCC				
478		30 14		2	3	4 5		7 8 9	---/DCC				
479		30 15	1 2	3	4 5			7 8 9	---/DCC				
480		30 16					6	7 8 9	---/DCC				
481		31 1	1					6 7 8 9	---/DCC				
482		31 2		2				6 7 8 9	---/DCC				
483		31 3	1 2					6 7 8 9	---/DCC				
484		31 4			3			6 7 8 9	---/DCC				
485		31 5	1		3			6 7 8 9	---/DCC				
486		31 6		2	3			6 7 8 9	---/DCC				
487		31 7	1 2	3				6 7 8 9	---/DCC				
488		31 8				4		6 7 8 9	---/DCC				
489		31 9	1			4		6 7 8 9	---/DCC				
490		31 10		2		4		6 7 8 9	---/DCC				
491		31 11	1 2		4			6 7 8 9	---/DCC				

												10 (0/1)		
492	31	12			3	4		6	7	8	9	---	/ DCC	
493	31	13	1		3	4		6	7	8	9	---	/ DCC	
494	31	14		2	3	4		6	7	8	9	---	/ DCC	
495	31	15	1	2	3	4		6	7	8	9	---	/ DCC	
496	31	16						5	6	7	8	9	---	/ DCC
497	32	1	1					5	6	7	8	9	---	/ DCC
498	32	2		2				5	6	7	8	9	---	/ DCC
499	32	3	1	2				5	6	7	8	9	---	/ DCC
500	32	4			3			5	6	7	8	9	---	/ DCC
501	32	5	1		3			5	6	7	8	9	---	/ DCC
502	32	6		2	3			5	6	7	8	9	---	/ DCC
503	32	7	1	2	3			5	6	7	8	9	---	/ DCC
504	32	8				4		5	6	7	8	9	---	/ DCC
505	32	9	1			4		5	6	7	8	9	---	/ DCC
506	32	10		2		4		5	6	7	8	9	---	/ DCC
507	32	11	1	2		4		5	6	7	8	9	---	/ DCC
508	32	12			3	4		5	6	7	8	9	---	/ DCC
509	32	13	1		3	4		5	6	7	8	9	---	/ DCC
510	32	14		2	3	4		5	6	7	8	9	---	/ DCC
511	32	15	1	2	3	4		5	6	7	8	9	---	/ DCC

Adressen größer 511 können nur im DCC Format ausgegeben werden und müssen mit der CV Programmierung über das Programmiergleis durchgeführt werden.

Addresses larger than 511 can only be assigned in the DCC format and must be done by programming a CV using the programming track.

Les adresses supérieures à 511 peuvent uniquement être éditées dans le format DCC et doivent être exécutées avec la programmation des CV via la voie de programmation.

Adressen groter dan 511 kunnen alleen in het DCC formaat gebruikt worden en moeten met de CV programmering via het programmeerspoor ingesteld worden.

Las direcciones superiores a 511 pueden mostrarse en el formato DCC y deben configurarse con la función Programación de CVs mediante la vía de programación.

Indirizzi maggiori di 511 possono essere assegnati solo nel formato DCC e si devono eseguire con la programmazione delle CV tramite il binario di programmazione.

Adresser överstigande 511 kan endast skrivas in i DCC-format och måste göras med CV-programmering med loket på programmeringspåret.

Adresser højere end 511 kan kun udtrykkes i DCC format og skal udføres med CV programmeringen via programmeringsporet.

Aufbau • Setup • Montage • Opbouwen • Montaje • Montaggio • Montering • Forsamling

Kabelfarben Colors for the Wires Couleurs des câbles Draadkleuren Colores de los cables Colori dei cavetti Kabelfärgerna Kabelfarverne

- 1 rot / red / rouge / rood /
rojo / rosso / röd / rød
- 2 braun / brown / brun / bruin /
marrón / marrone / brun / brun
- 3 gelb / yellow / jaune / geel /
amarillo / giallo / gul / gul
- 4 violett / violett / violet / paars /
violeta / viola / violett / violet
- 5 rot-braun / red-brown / rouge-brun / rood-bruin /
rojo-marrón / rosso-marrone / röd-brun / rød-brun
- 6 rot-grün / red-green / rouge-vert / rood-grøen /
rojo-verde / rosso-verde / röd-grön / rød-grøn

Anschluss Programmiergleis
Connections for the Programming Track
Branchement voie de programmation
Aansluiten op het programmeerspoor
Conexión de la vía de programación
Collegamento del binario di programmazione
Anslutning till programmeringsspåret
Tilslutning programmeringsskinne

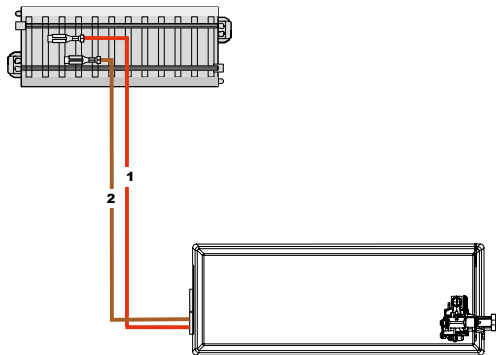

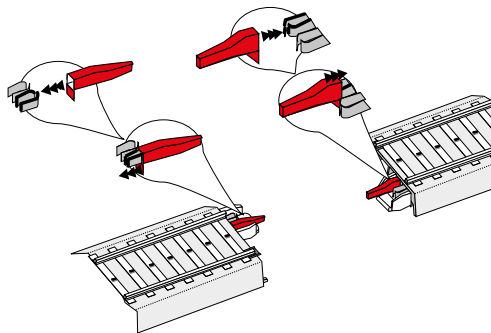
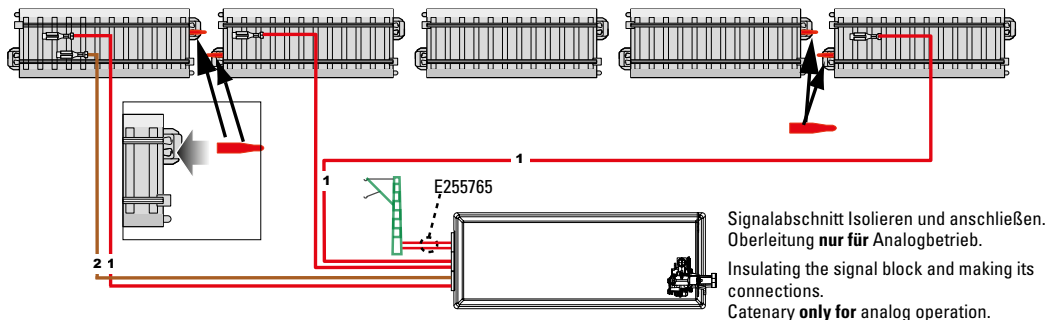

Isoler la partie du signal et branchez.
Caténaire **seulement pour** exploitation analogique.

Stopsectie isoleren en aansluiten.
Bovenleiding **alleen in** analoogbedrijf.

Aislamiento y conexión del tramo de señal.
Corriente por catenaria **solo modo** analógico.

Isolamento e connessioni della tratta del segnale.
Catenaria **solo per la** modalità analogica.

Isolering av och anslutning av ett spåravsnitt.
Kontaktledning **bara för** analogt läge.

Isolér og tilslut signalafsnit.
Køreledninger **kun for** analog tilstand.

Befestigung am C-Gleis
Installation with C Track
Fixation à la voie C
Bevestiging aan C-rail
Sujeción a la vía C
Fissaggio al binario C
Fastsättning vid C-räls
Fastgørelse på C-skinne

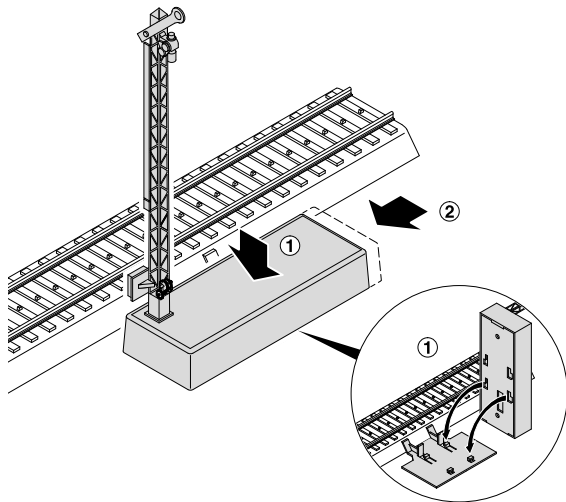
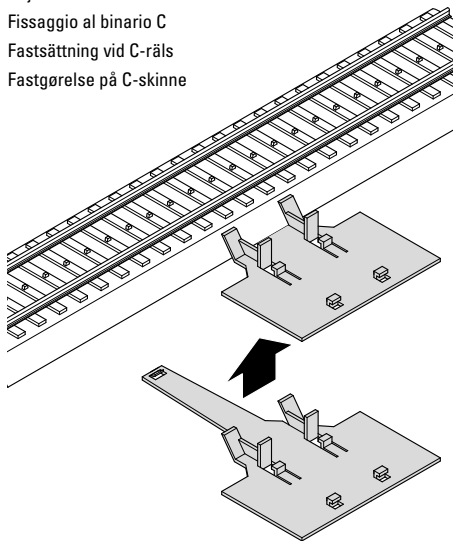

Befestigung am K-Gleis oder anderen Gleissystemen
Installation with K Track or Other Track Systems
Fixation à la voie K ou à d'autres systèmes de voies
Befestiging aan K-rail of ander railsysteem
Sujeción a la vía K u a otros sistemas de vías
Fissaggio al binario K oppure altri sistemi di binario
Fastsättning vid K-räls eller andra rärlssystem
Fastgørelse på K-skinne eller andre skinnesystemer

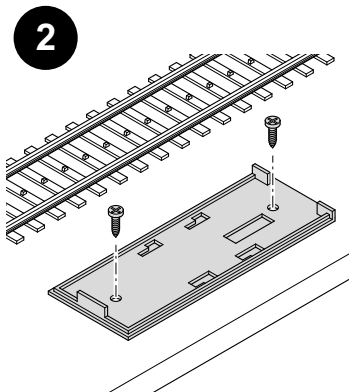
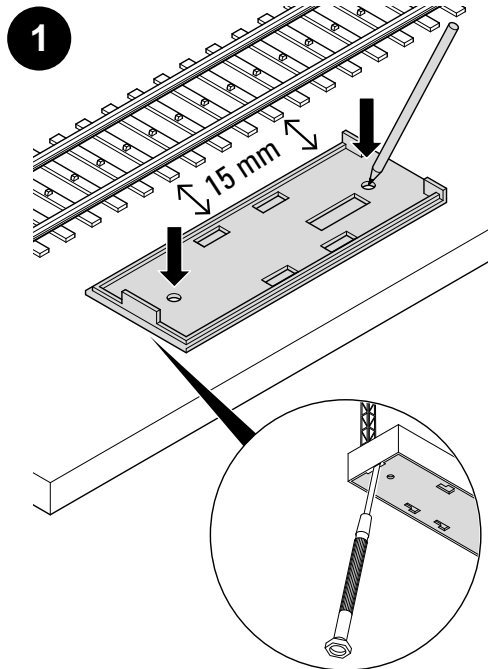

- Mit beiliegender Bohrschablone markieren (Unterflurmontage).
- Mark with the template included with the signal (Below-Baseboard Installation).
- Marquer avec le patron de perçage ci-joint (Montage souterrain).
- Met meegeleverde sjabloon markeren (Ondervloermontage).
- Marcar con la plantilla de taladros adjunta (Montaje bajo el suelo).
- Marcare con l'acclusa maschera di foratura (Montaggio sotto plancia).
- Markera med hjälp av medföljande borrhållsblon (Montage under anläggningen).
- Markér med vedlagte boreskabelon (Underhængt montering).

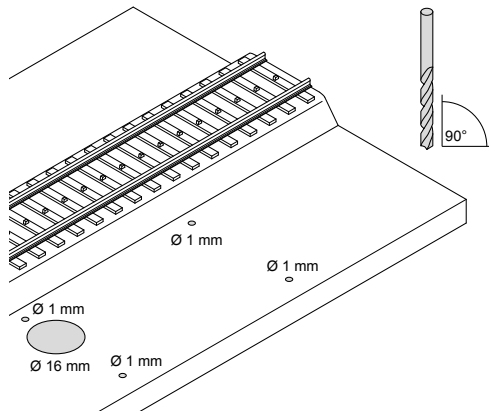
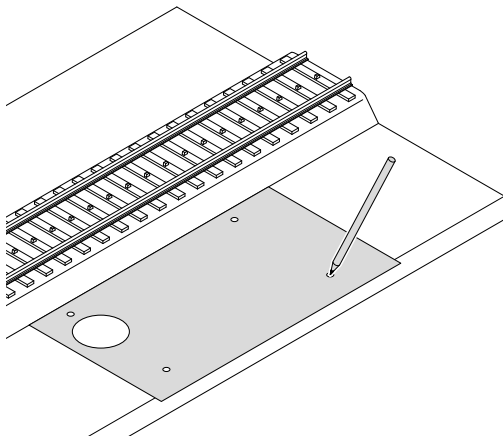

Steckteile entfernen

Remove detail parts.

Ôter les connecteurs

Opsteekdelen verwijderen

Desmontaje de las piezas enchufables

Rimuovere gli elementi a innesto

Avl agsna insticksdelar

Fjern stikdele

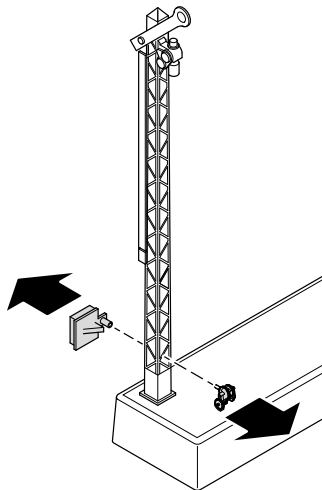

Unterflurmontage:

Below-Baseboard Installation:

Montage souterrain :

Ondervloermontage:

Montaje bajo el suelo:

Montaggio sotto plancia:

Montage under anläggningen:

Underhængt montering:

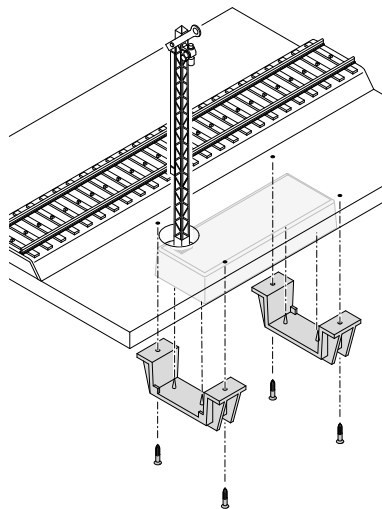
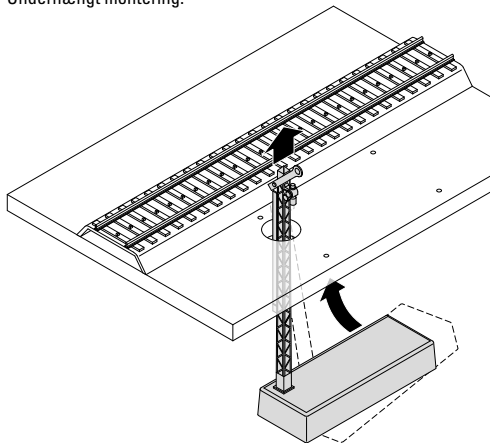

Abdeckung anbringen

Install the cover

Poser le couvercle

Afdekking aanbrengen

Colocar la cubierta

Applicare il coperchio

Sätt på locket

Anbring afdækning

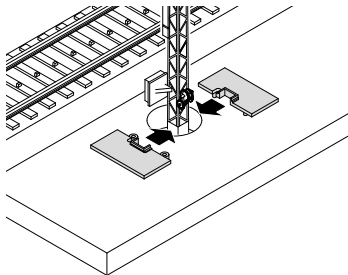

Steckteile nach erfolgter Unterflurmontage wieder anbringen.

Reinstall detail parts after completing below-baseboard installation.

Remonter les connecteurs après le montage souterrain.

Opsteekdelen na succesvolle ondervloermontage weer aanbrengen.

Colocar de nuevo las piezas enchufables una vez realizado el montaje bajo el suelo.

Applicare di nuovo gli elementi a innesto dopo avvenuto montaggio sotto plancia.

Efter montage av signalen under anläggningen sätts insticksdelarna tillbaka.

Anbring stikdele efter gennemført underhængt montering.

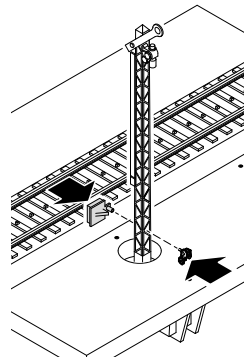

Anschluss Bremsmodul 72441/72442

Connections for the 72441/72442 Braking Module

Branchement module de freinage 72441/72442

Aansluiten afremmodule 72441/72442

Conexión del módulo de frenado 72441/72442

Conessioni del modulo di frenatura 72441/72442

Anslutning av bromsmodul 72441/72442

Tilslutning bromsemodul 72441/72442

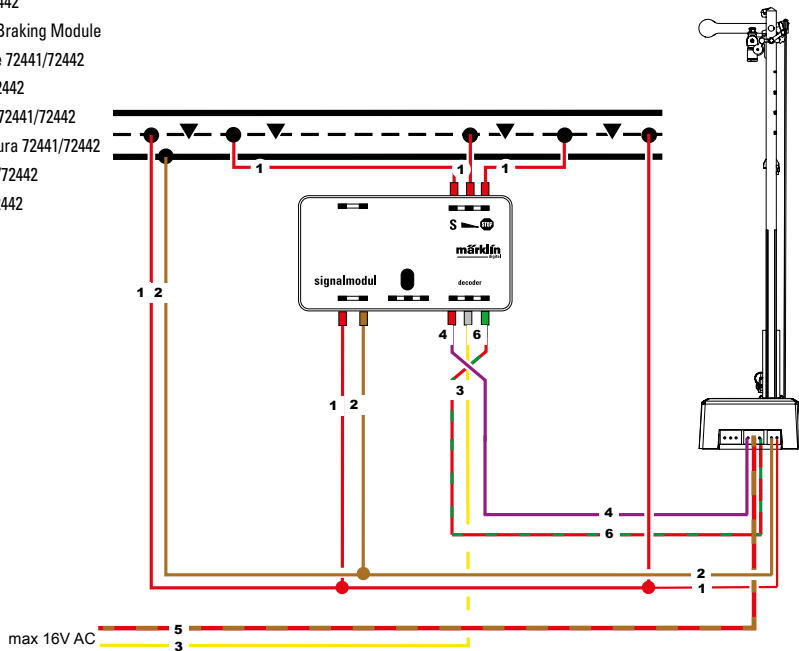

**Aufkleber anbringen • Attach decals • Fixez les autocollants • Bvestig stickers •
 Allega decalcomanie • Coloque las calcomanías • Bifoga dekaler • Vedhæft decals**

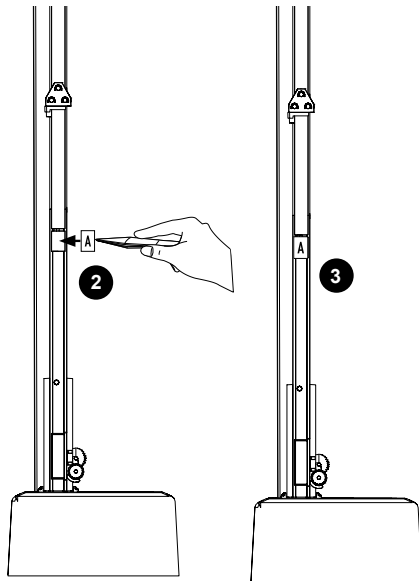
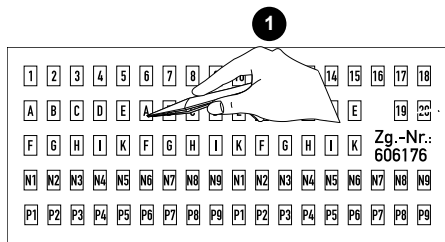

**Bohrschablone • Drilling Template • Gabarit de perçage • Boorsjabloon •
Plantilla • Maschera di Foratura • Borrschablon • Boreskabelon**

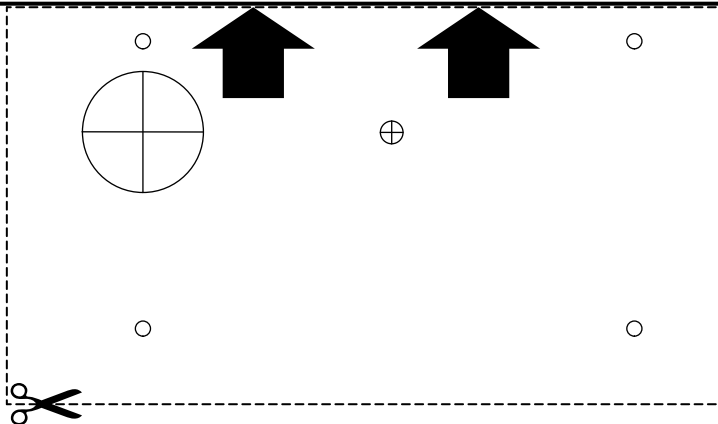
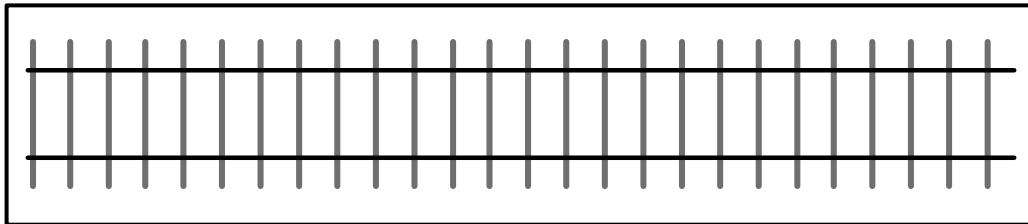

Gebr. Märklin & Cie. GmbH
Stuttgarter Straße 55 - 57
73033 Göppingen
Germany
www.maerklin.com

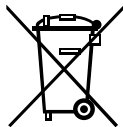

www.maerklin.com/en/imprint.html

236105/0520/Sc10Pw
Änderungen vorbehalten
© Gebr. Märklin & Cie. GmbH