



# Montageanleitung

## Mounting instruction

### N Marktplatz Miltenberg

### N Market place Miltenberg

DE

1. Wichtige Hinweise .....	1
2. Inhalt .....	2
3. Montage .....	3

EN

1. Important information .....	1
2. Contents .....	2
3. Mounting .....	3

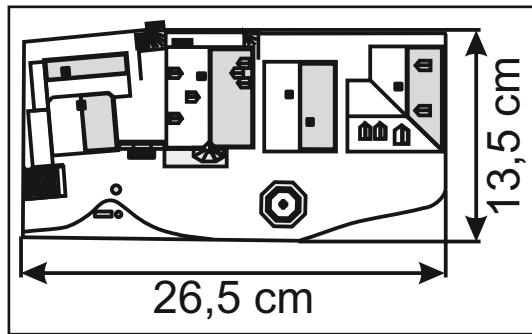

Die aktuelle Version der Anleitung finden Sie auf der kibri-Homepage unter der Artikelnummer.  
You will find the latest version of the manual on the kibri website using the item-No.

Änderungen vorbehalten. Keine Haftung für Druckfehler und Irrtümer.  
Subject to change without prior notice. No liability for mistakes and printing errors.

**viessmann** Modelltechnik GmbH  
Bahnhofstraße 2a  
D - 35116 Hatzfeld-Reddighausen  
info@viessmann-modell.com  
+49 6452 9340-0  
www.viessmann-modell.de

Schwierigkeitsgrad  
der Bausätze:  
Level of difficulty:



Made in Europe

86261  
Stand 04/sw  
07/2023  
TSz/Ho

DE

## 1. Wichtige Hinweise

Bitte halten Sie beim Zusammenbau unbedingt die Reihenfolge der Bauabschnitte ein!

### Sicherheitshinweise



#### Verletzungsgefahr!

Aufgrund der detaillierten Abbildung des Originals bzw. der vorgesehenen Verwendung kann das Produkt Spitzen, Kanten und abbruchgefährdete Teile aufweisen. Für die Montage sind Werkzeuge nötig.

#### Montage des Bausatzes

Die beim jeweiligen Montageschritt benötigten Teile trennen Sie bitte mit einem Seitenschneider bzw. Modellbaumesser vorsichtig vom Spritzbaum ab und entgraten die Ränder.

Da Spritzlinge für mehrere Artikel verwendet werden, kann es sein, dass bei diesem Bausatz einige Teile übrig bleiben.

Dieser Bausatz wurde sorgfältig geprüft und verpackt. Sollte es trotzdem einmal vorkommen, dass ein Teil fehlt, fordern Sie dieses bitte per E-Mail oder per Post bei uns an. Bitte nennen Sie uns die Bezeichnung und Artikel-Nummer des Bausatzes sowie Spritzling- und Teile-Nr. Diese Angaben finden Sie in der Bauanleitung. Sie erhalten dann umgehend von uns Ersatz.

Passenden Kleber für die Bausätze finden Sie im kibri Sortiment.

DE

Hochauflösende Druckvorlagen für Beschriftungen und Beschilderungen finden Sie auf unserer Homepage [www.kibri.de](http://www.kibri.de) in der Rubrik Service – Download. Die Dekobögen lassen sich auf einem handelsüblichen Farbdrucker ausdrucken. Für den jeweiligen Druckertyp (Tintenstrahl oder Laser) geeignetes Papier bzw. Folie gibt es im Schreibwarenfachhandel. Ideal sind selbstklebende, glatte Papiere oder Folien mit geringer Materialstärke.

**Ausdrucken – ausschneiden – aufkleben – fertig!**

Kataloge von Viessmann und kibri/Vollmer können auch bequem über das Internet angefordert werden.  
Catalogues by Viessmann and kibri/Vollmer can be ordered alternatively via internet.



EN

## 1. Important information

Please observe the correct sequence when assembling the parts to sub-assemblies and to the completed product!

### Safety information



#### Risk of injury!

Due to the finely detailed reproduction of the original and the intended use, this product may have sharp points or edges as well as parts that may easily break off. Some tools are required for assembly.

#### Assembly

Carefully separate the parts required for the respective assembly phase with a side cutter or a sharp utility knife from the injection-moulded sprue and deflash the edges.

Since some sprues are used for several different products it is quite possibly that some parts may not be needed for this particular product.

The contents of this kit have been carefully checked against the parts list. However, should a part be missing please contact us by e-mail or by sending a letter. Please state the precise product description and the item-No. as well as the No. of the sprue and the specific part that is missing. You will find all necessary information in this manual. We will promptly supply the missing parts.

You will find suitable glue for the kits in the kibri product range.

EN

The high-resolution master copy for all kind of signs in your kibri kit are available as download for free. Deco sheets can be printed by using a standard colour printer. Suitable paper or foil for the respective printers are offered by specialized trade. Best way is to use self-adhesive smooth papers or foil with low material thickness.

**Print – cut – stick – ready!**

## 2. Inhalt

Kontrollieren Sie nach dem Auspacken den Lieferumfang auf Vollständigkeit:

- Haftetikett 548, 549, 550, 551, 552
- Dekopapier 87884
- Schwarzes Papier
- Anleitung

## 2. Contents

Check the contents of the package for completeness after unpacking:

- Sticker 548, 549, 550, 551, 552
- Decoration sheet 87884
- Black paper
- Manual

Teile-Nr.	Stück	Teile-Nr.	Stück	Teile-Nr.	Stück	Teile-Nr.	Stück	Teile-Nr.	Stück
E520	1	E563	1	E602	1	E647	1	E690	1
E521	1	E564	1	E603	4	E648	1	E691	1
E522	1	E565	1	E604	4	E649	1	E692	3
E523	1	E566	1	E605	3	E650	1	E693	4
E524	1	E567	1	E606	1	E651	1	E694	1
E525	1	E568	1	E607	1	E652	1	E695	1
E526	1	E569	1	E608	1			E696	4
E527	1	E570	1	E609	1	E653	1	E697	2
E528	1	E571	1	E610	1	E654	4	E698	2
		E572	1	E611	2	E655	1	E699	1
E529	1			E612	3			E700	1
E530	1	E573	1	E613	1	E656	1	E701	2
E531	1	E574	2	E614	1	E657	1	E702	2
E532	1	E575	1			E658	1	E703	1
E533	1	E576	1	E620	1	E659	2	E704	2
E534	1	E577	1	E621	1	E660	4	E705	1
E535	1	E578	1	E622	1	E661	1	E706	1
E536	1	E579	4	E623	1	E662	3	E707	4
E537	1	E712	1	E624	2	E663	1	E719	1
E538	1	E713	1	E625	1	E667	1		
E539	1	E715	1	E710	1	E668	1	E720	1
E540	1	E716	1	E711	1			E721	1
E541	1	E717	1			E669	4	E722	1
E542	1	E718	2	E626	1	E670	2	E723	1
E543	1			E627	1	E671	2	E724	1
E544	1	E582	1	E628	1	E672	1	E725	1
E545	1	E583	1	E629	1	E673	1	E726	1
E546	1	E584	1			E674	2	E727	1
		E585	1	E630	1	E675	1	E728	1
E547	1	E586	3	E631	1	E676	1	E729	1
E548	1	E587	1	E632	4	E677	1	E730	1
E549	2	E588	1	E633	1	E678	1	E731	1
E550	2	E589	1	E634	2	E679	1	E732	1
E551	2	E590	1	E635	1	E680	2		
E552	2	E591	2	E636	6	E681	2	E733	1
E553	2	E592	1	E637	1	E682	2		
E554	2	E593	1	E638	1	E683	2		
E555	2	E594	1	E639	1	E684	2		
E556	1	E595	1	E640	2	E685	3		
E557	1	E596	1			E686	6		
E558	1	E597	1	E641	1	E687	1		
		E598	2	E642	1	E688	1		
E559	1	E599	1	E643	1	E689	4		
E560	1	E600	1	E644	6				
E561	1	E601	1	E645	1				
E562	1	E714	1	E646	1				
E615	1								
E616	1								

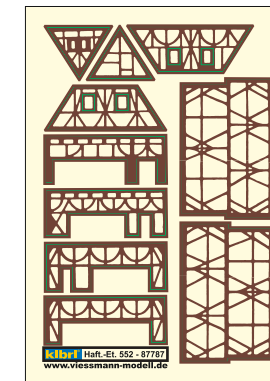
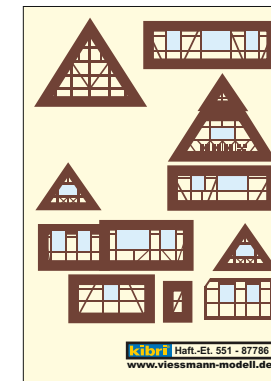
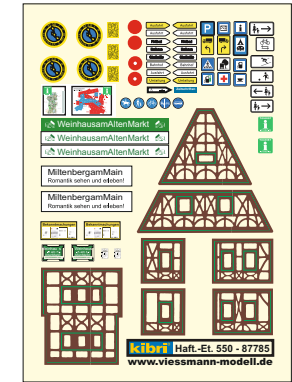
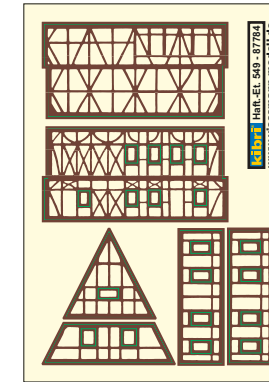
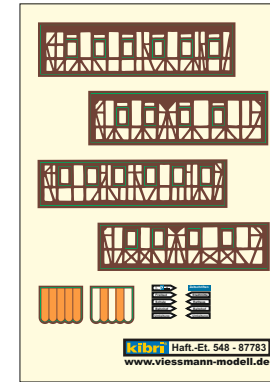

3. Montage  
Mounting

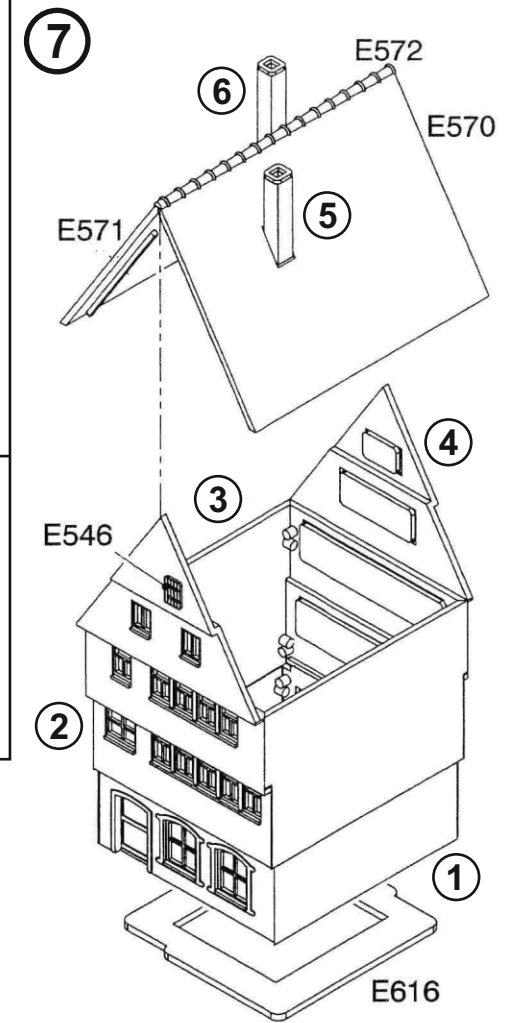
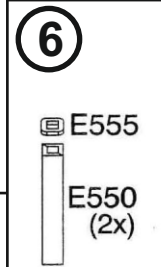
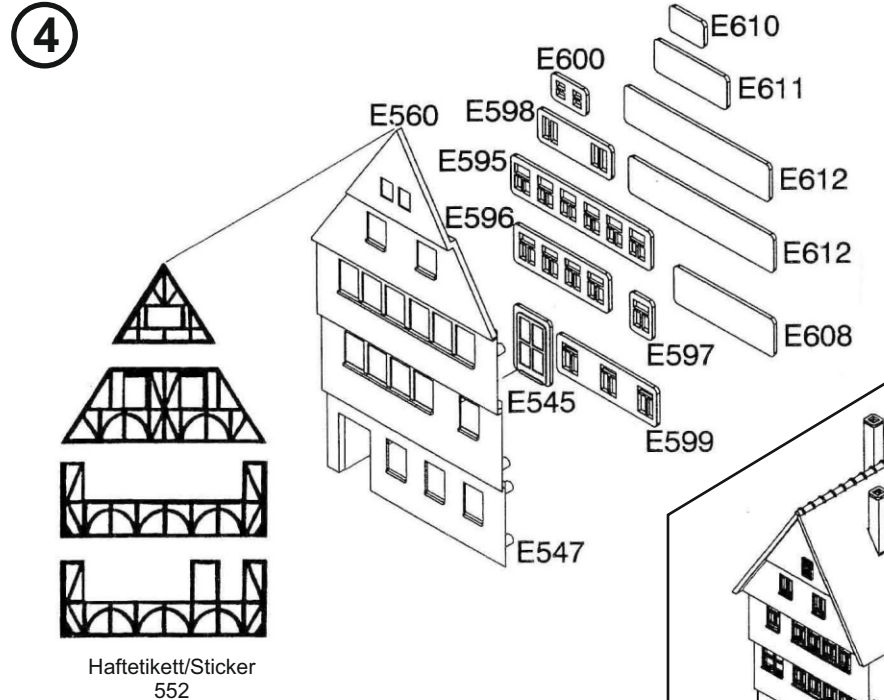
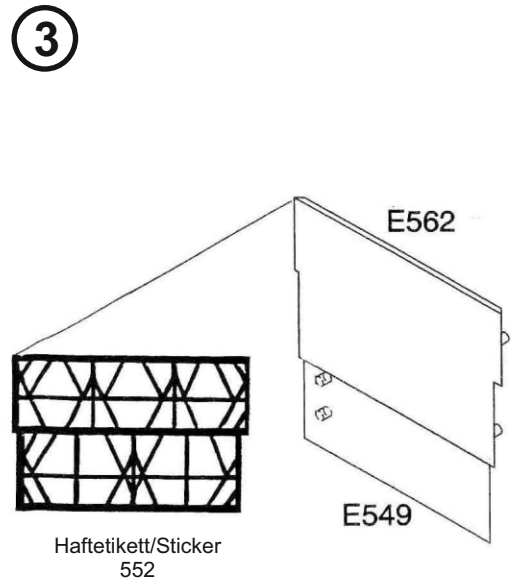
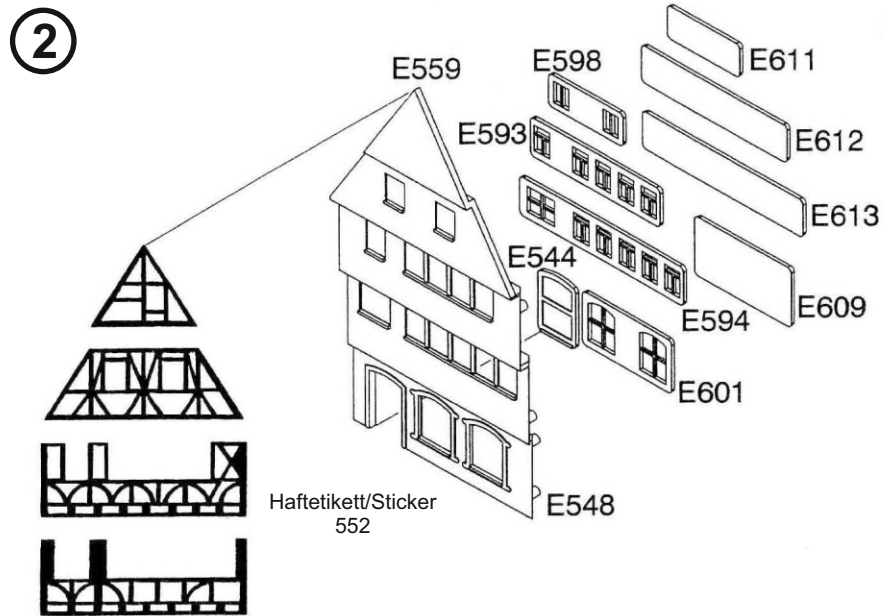
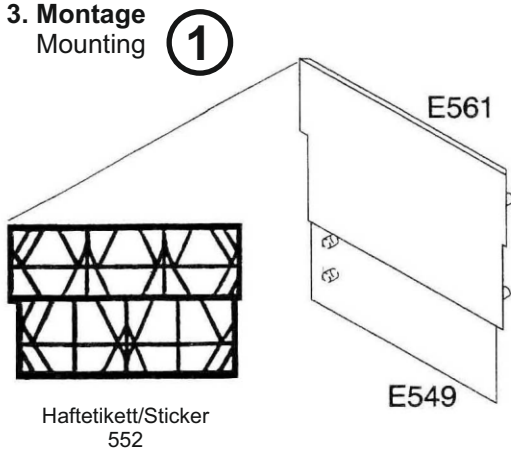

**Tipp:**  
Verwenden Sie das beiliegende schwarze Papier zum Abdunkeln des Modells von innen.

**Tip:**  
Use the enclosed black paper to shade the model from inside.

**Tipp:**  
Möchten Sie das Modell von innen beleuchten, verwenden Sie bitte die **viessmann Art. 6832** Hausbeleuchtungssockel mit Glühlampe E5,5, klar.

**Tip:**  
To illuminate the complete model from inside, please use **viessmann item 6832** House illumination socket with bulb E5,5, clear.

8

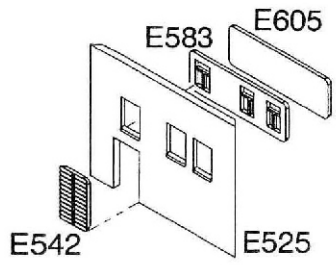

9

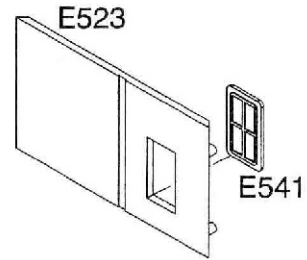

10

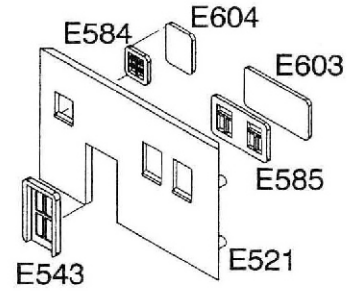

11

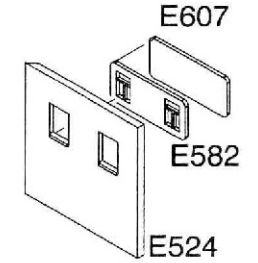

12

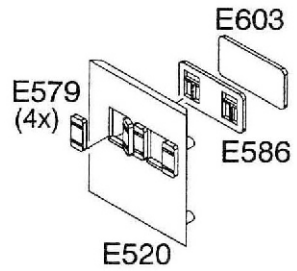

13

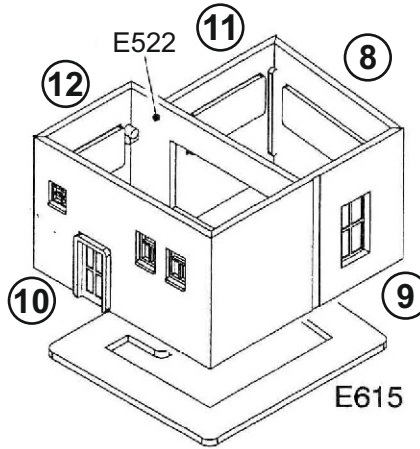

14

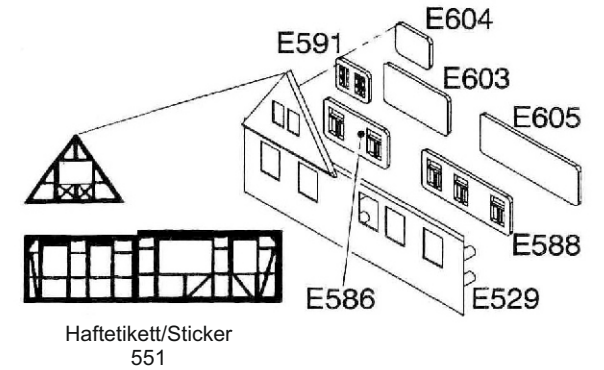

15

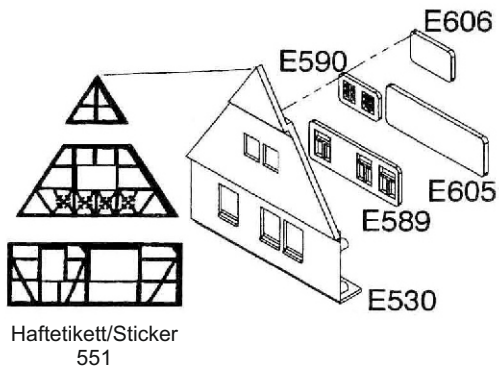

16

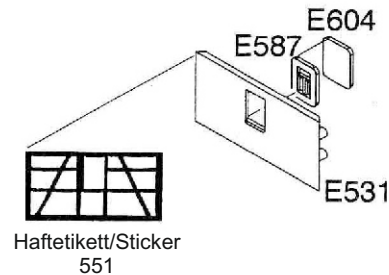

17

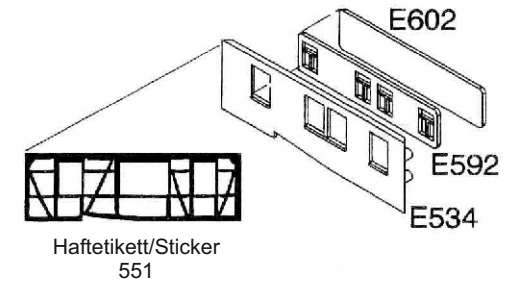



18

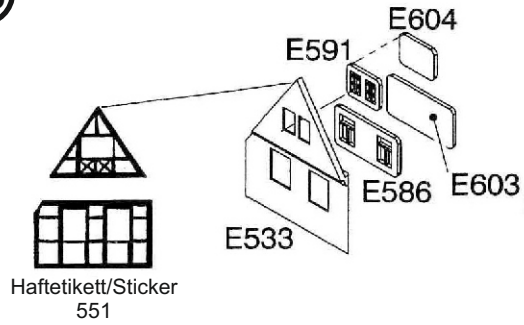

19

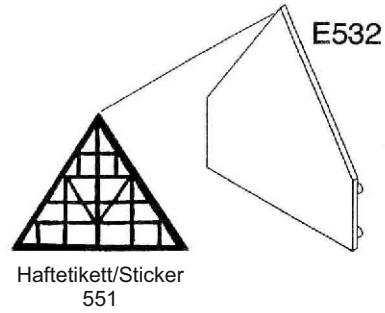

25

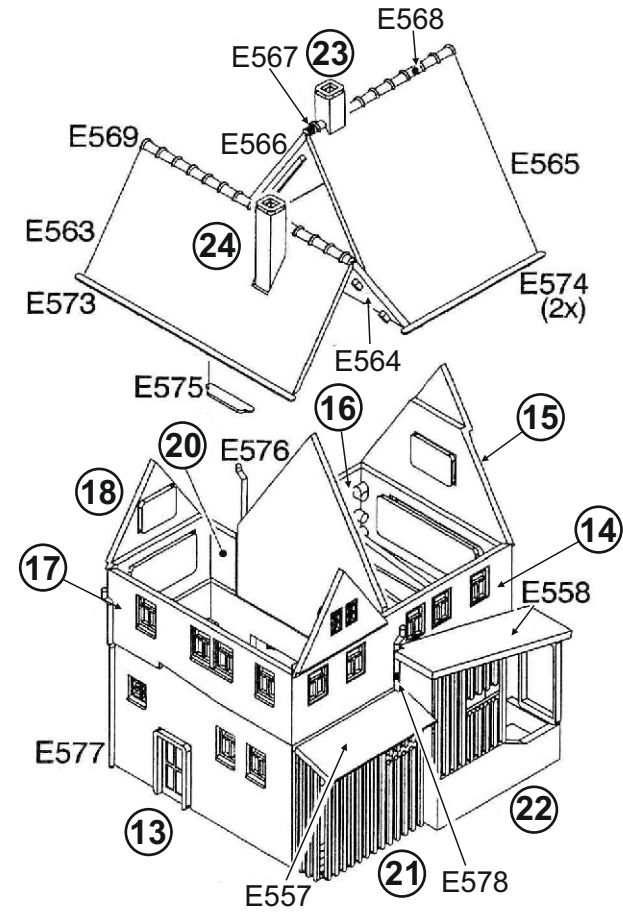

20

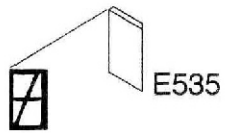

21

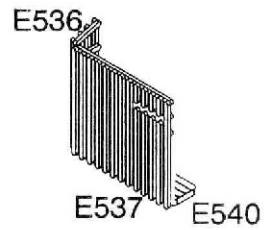

22

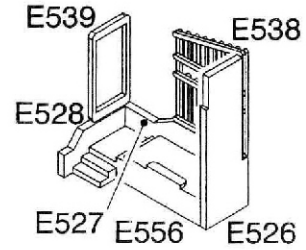

23

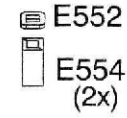

24

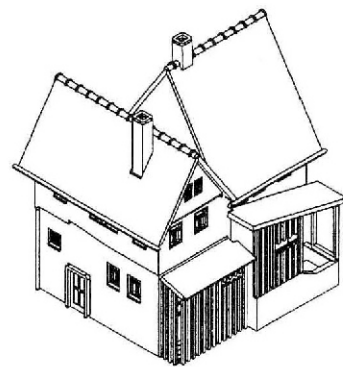
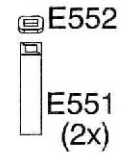

**Tipp:**

Verwenden Sie das beiliegende schwarze Papier zum Abdunkeln des Modells von innen.

**Tip:**

Use the enclosed black paper to shade the model from inside.

**Tipp:**

Möchten Sie das Modell von innen beleuchten, verwenden Sie bitte die **viessmann Art. 6832** Hausbeleuchtungssockel mit Glühlampe E5,5, klar.

**Tip:**

To illuminate the complete model from inside, please use **viessmann item 6832** House illumination socket with bulb E5,5, clear.

26

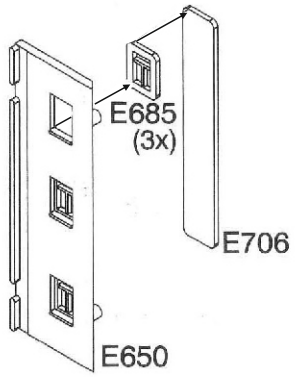

27

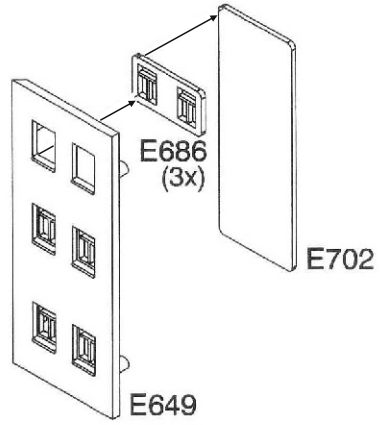

28

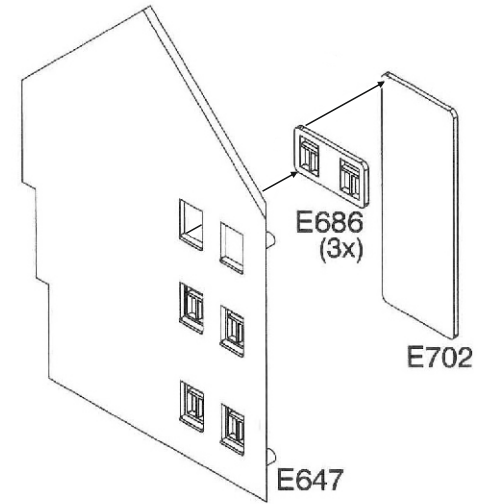

29

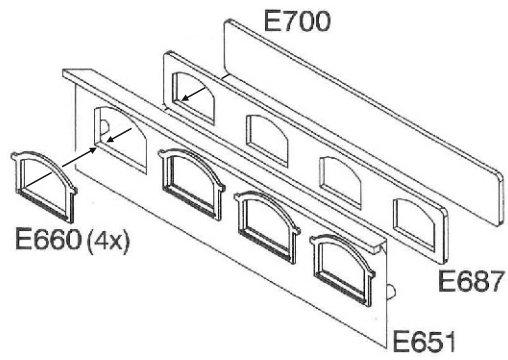

30

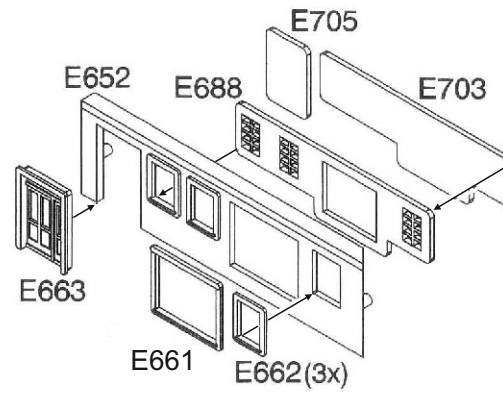

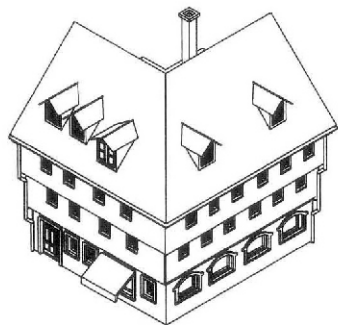
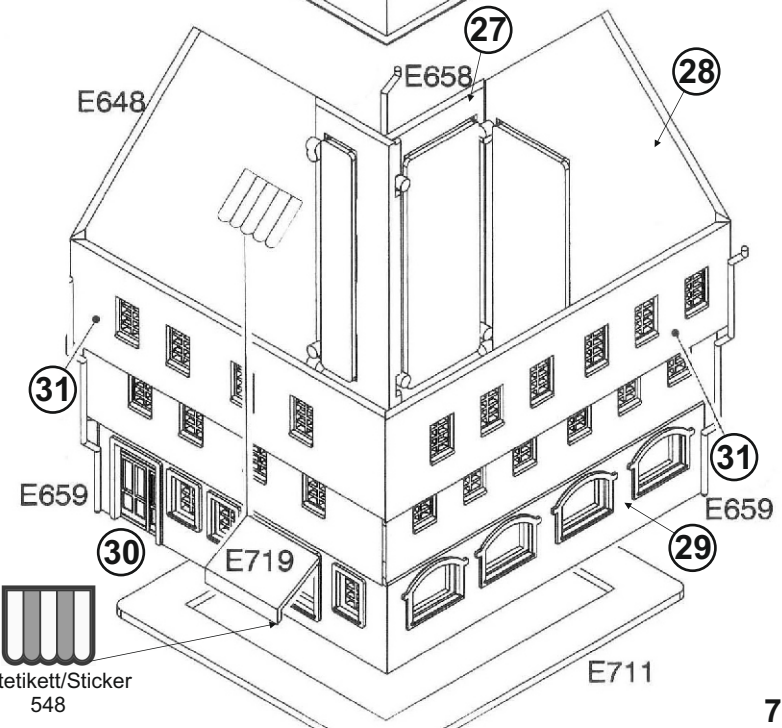
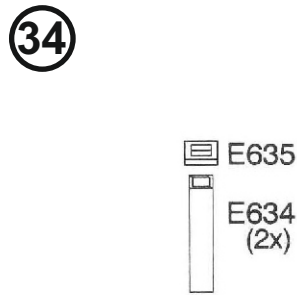
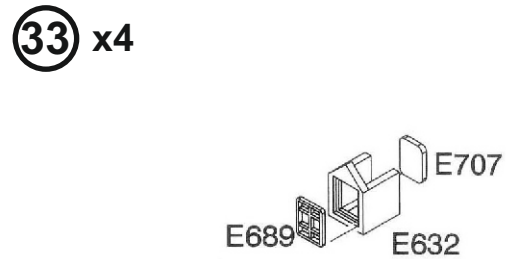
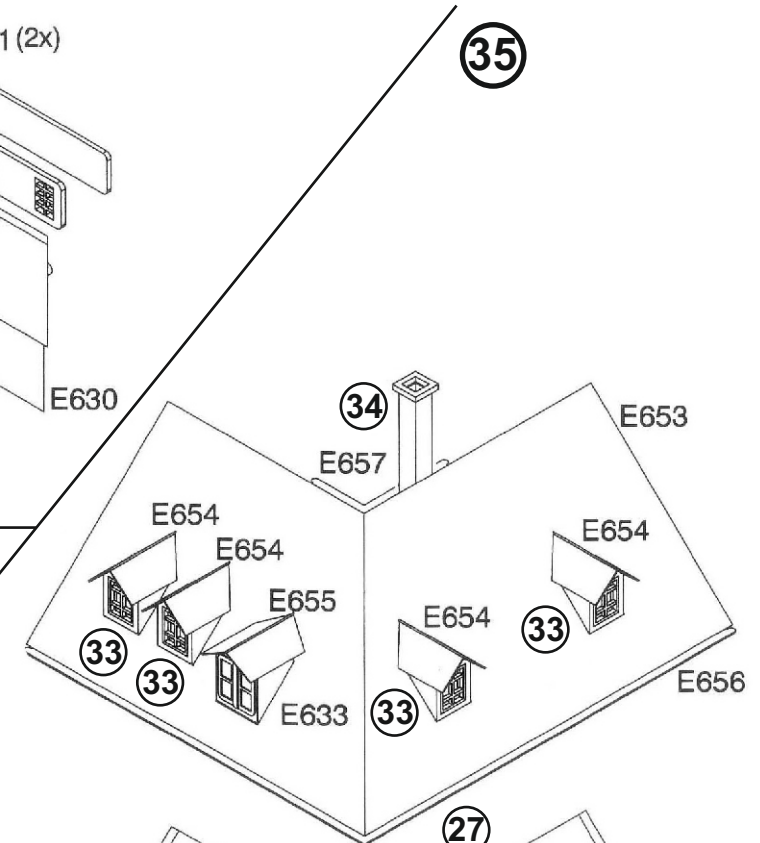
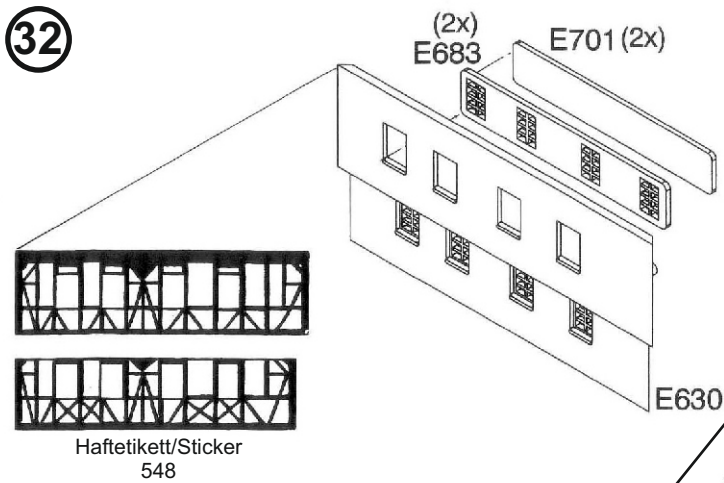
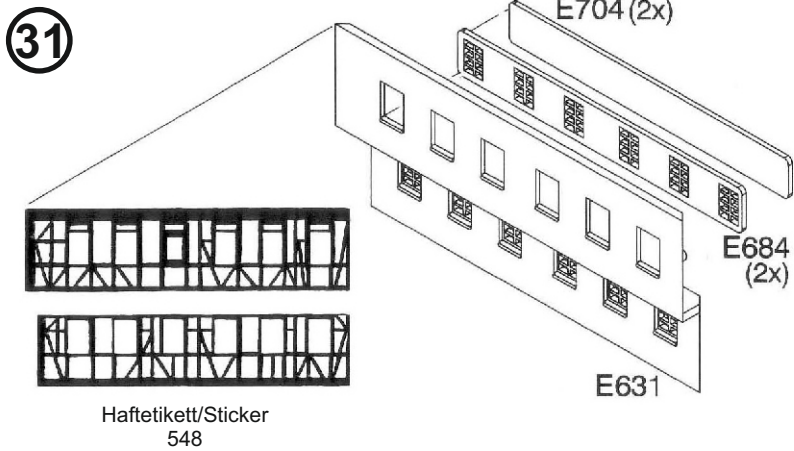

**Tipp:**  
Verwenden Sie das beiliegende schwarze Papier zum Abdunkeln des Modells von innen.

**Tip:**  
Use the enclosed black paper to shade the model from inside.

**Tipp:**  
Möchten Sie das Modell von innen beleuchten, verwenden Sie bitte die **viessmann Art. 6832** Hausbeleuchtungssockel mit Glühlampe E5,5, klar.

**Tip:**  
To illuminate the complete model from inside, please use **viessmann item 6832** House illumination socket with bulb E5,5, clear.

36

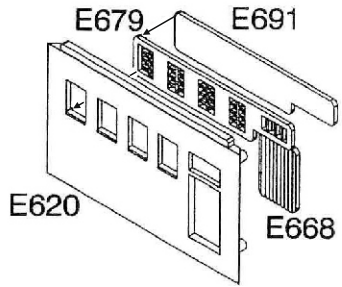

37

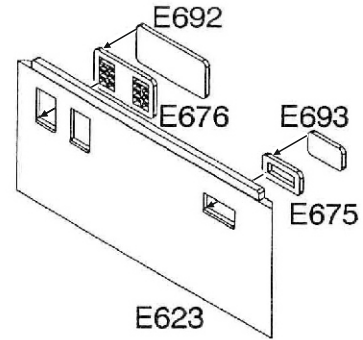

38

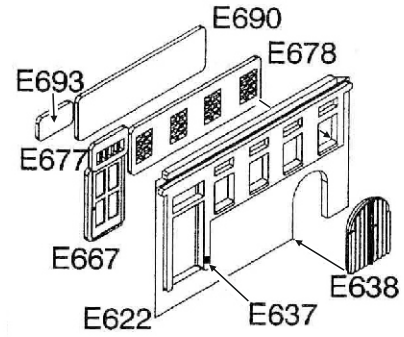

39

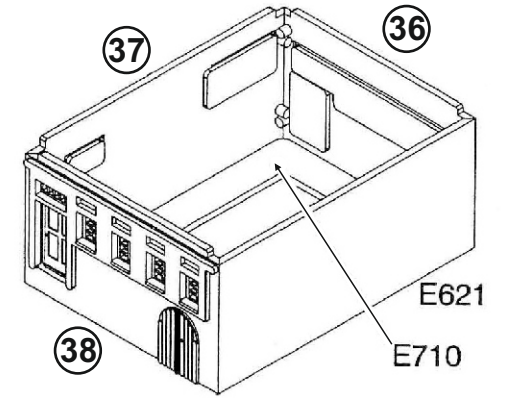

40

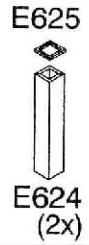

42

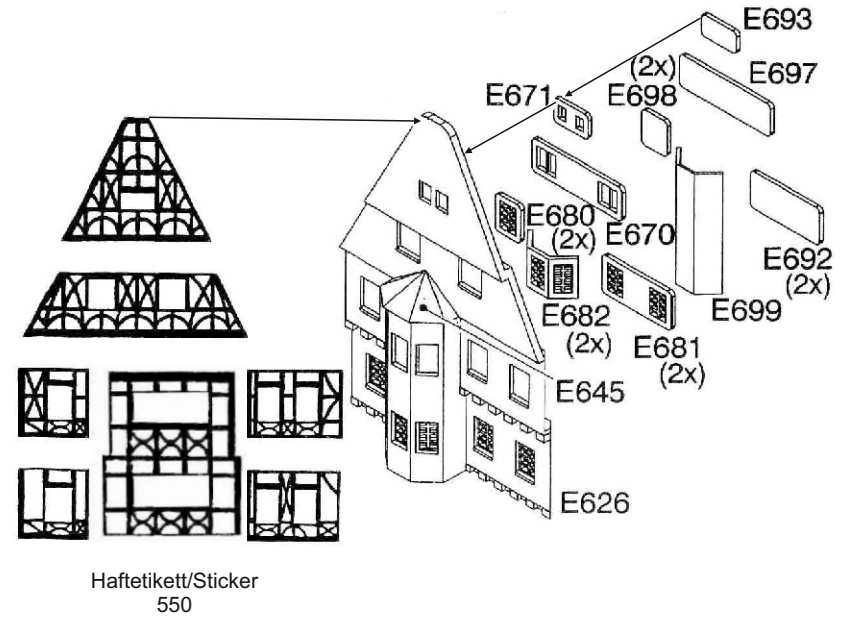

41

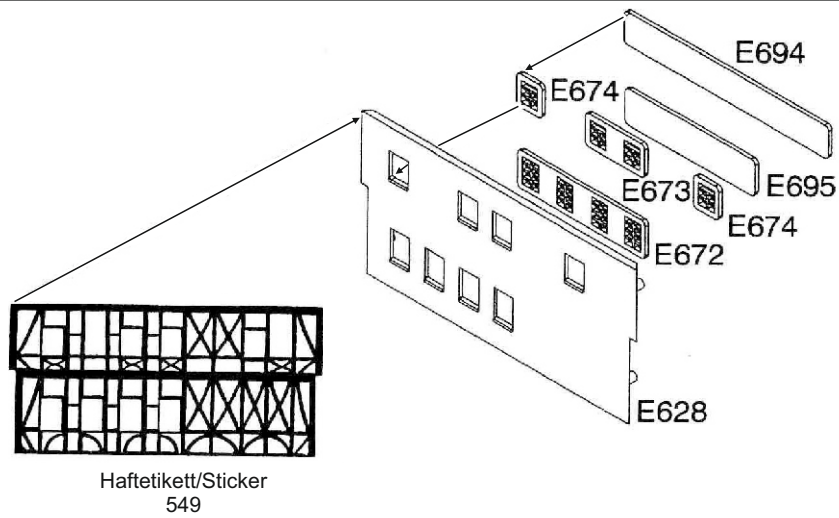



43

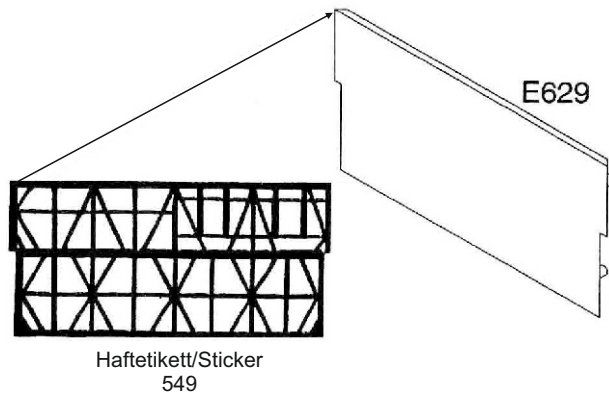

44

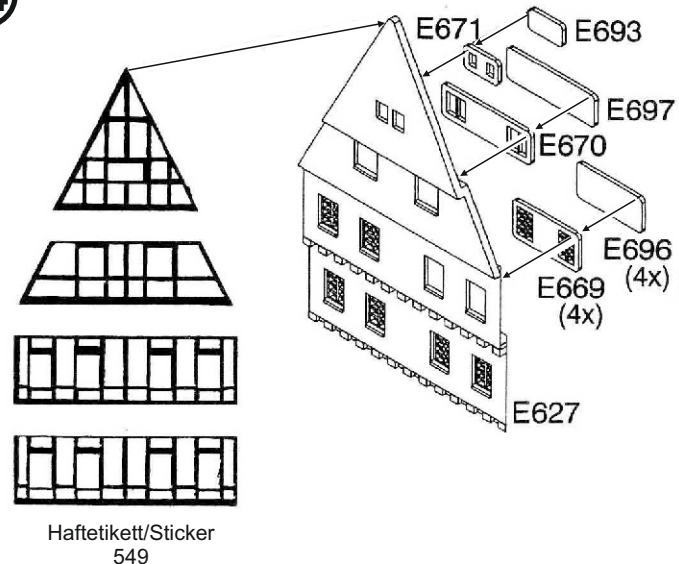

45

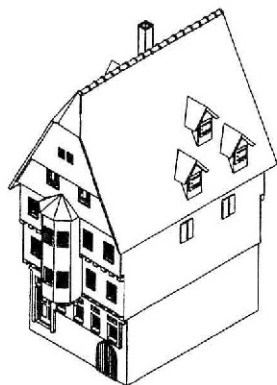
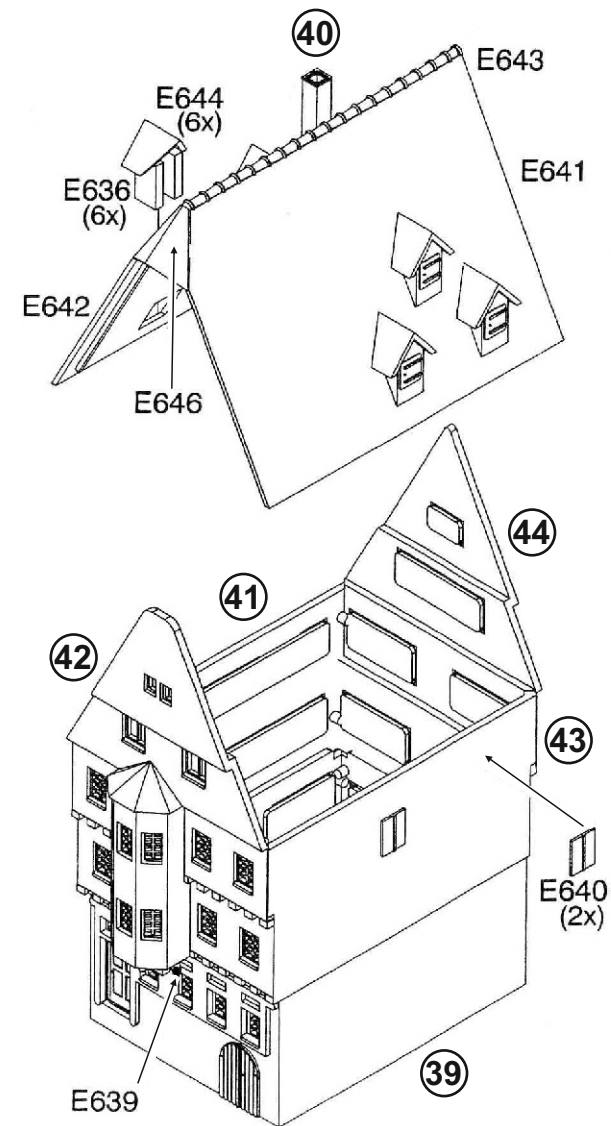

**Tip:**  
Verwenden Sie das beiliegende schwarze Papier zum Abdunkeln des Modells von innen.

**Tip:**  
Use the enclosed black paper to shade the model from inside.

**Tip:**  
Möchten Sie das Modell von innen beleuchten, verwenden Sie bitte die **viessmann Art. 6832** Hausbeleuchtungssockel mit Glühlampe E5,5, klar.

**Tip:**  
To illuminate the complete model from inside, please use **viessmann item 6832** House illumination socket with bulb E5,5, clear.

46

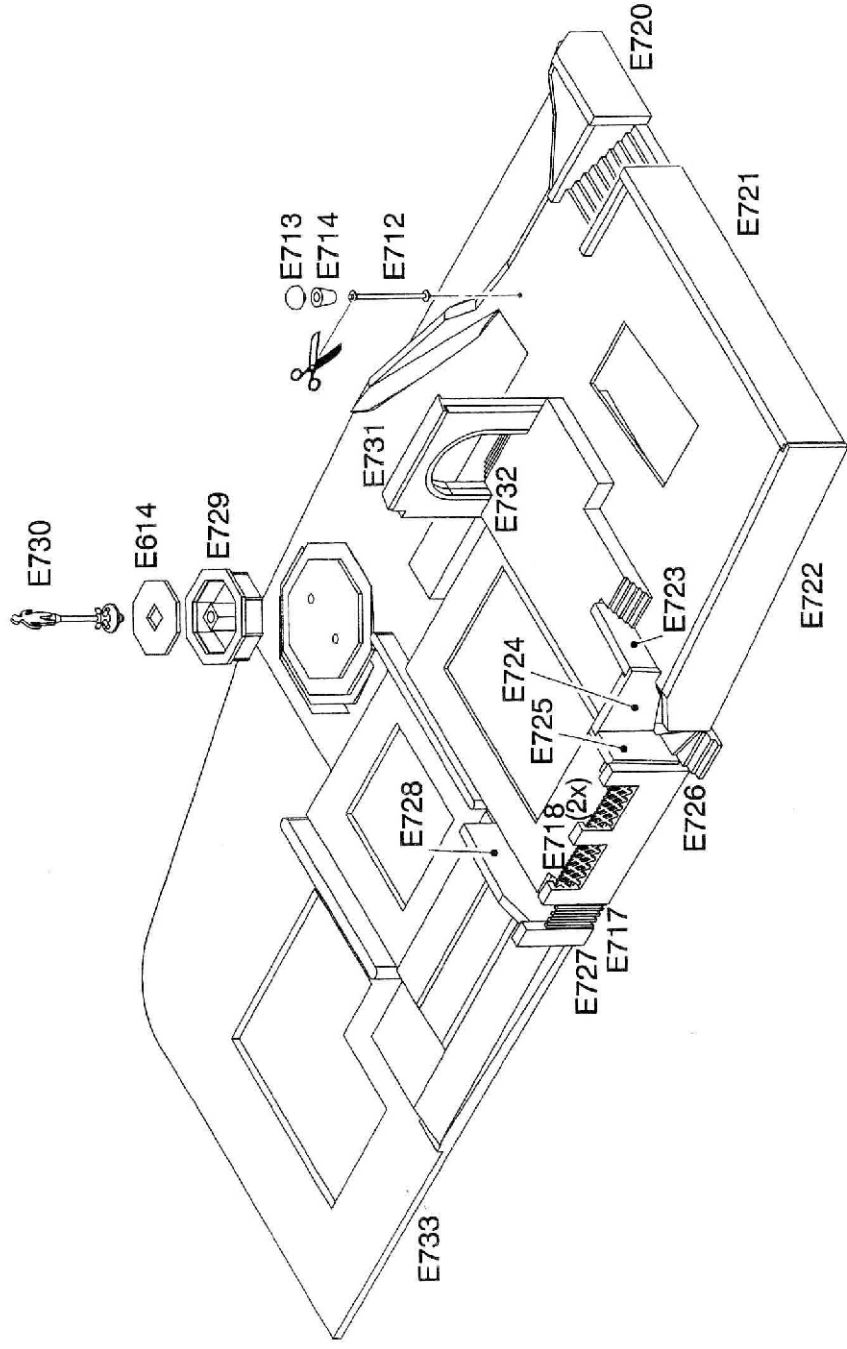

47

